



 **Objective**

The student will identify letters of the alphabet.

 **Materials**

- ▶ Uppercase and lowercase letter cards.
Choose eight to ten target pairs of uppercase and lowercase letter cards.

 **Activity**

Students pair uppercase and lowercase letters while playing a memory game.

1. Separate uppercase and lowercase letter cards. Place cards face down in different rows.
2. Taking turns, students select two cards and name the letter on each (e.g., “H, h” or “b, Q”).
3. Determine if there is a letter match. If there is a match (e.g., H, h), pick up cards, place to the side, and take another turn. If cards do not match (e.g., b, Q), return to their original positions and allow partner to take a turn.
4. Continue until all letter pairs are made.
5. Peer evaluation

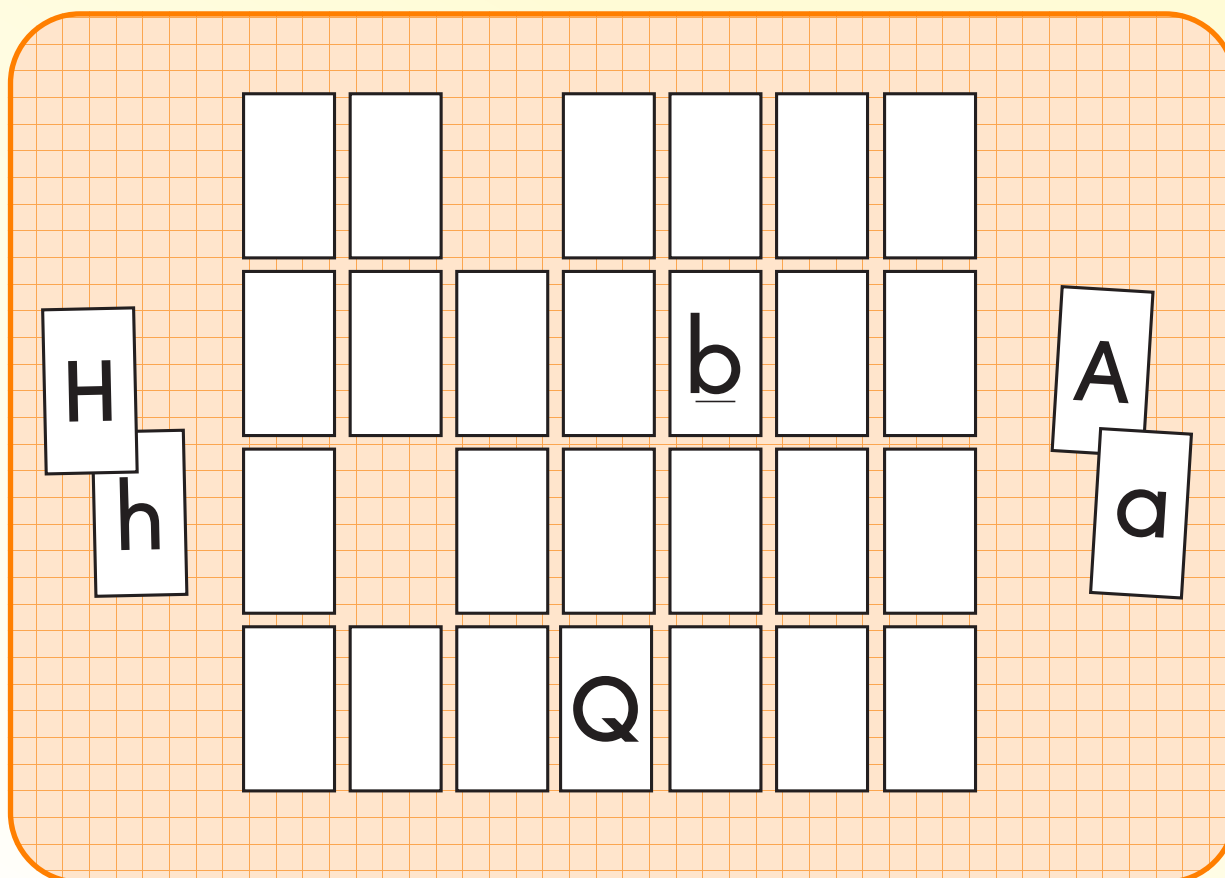

 **Extensions and Adaptations**

- ▶ Play using other target letters.
- ▶ Match letters to initial sound picture cards.

Phonics

Alphabet Memory Game

P.008

A

B

C

D

E

F

G

H

I

letter cards



J

K

L

M

N

O

P

Q

R

letter cards



Phonics

Alphabet Memory Game

P.008

S

T

U

V

W

X

Y

Z

a

letter cards



b

c

d

e

f

g

h

i

j

letter cards



Phonics

Alphabet Memory Game

P.008

k

l

m

n

o

p

q

r

s

letter cards



t

u

v

w

x

y

z

letter cards



Phonics

Alphabet Memory Game

P.008

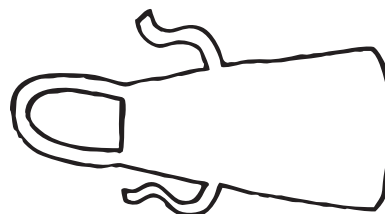
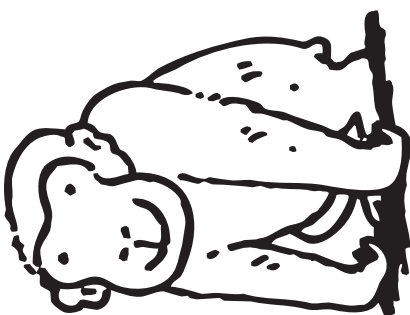
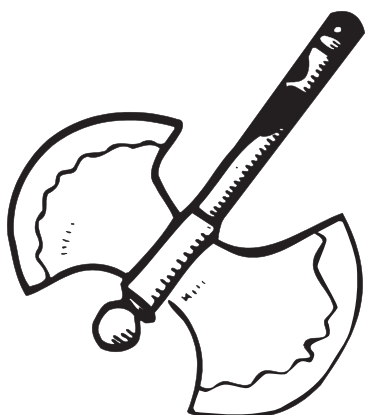
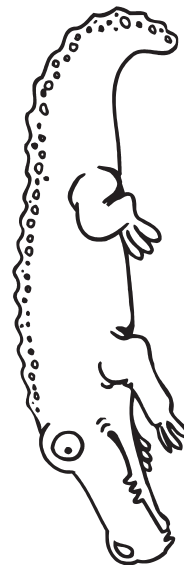
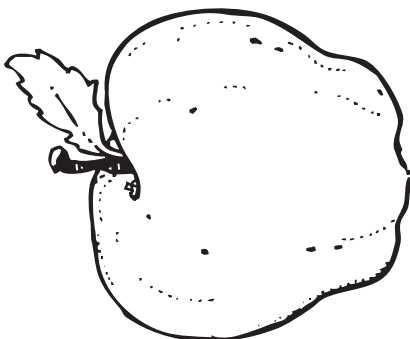
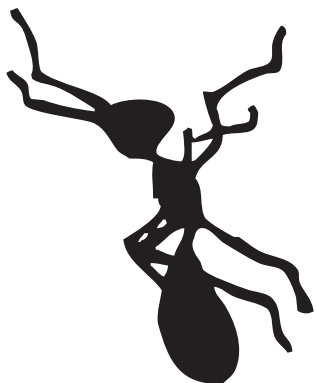

ant, apple, alligator, ax, ape, apron

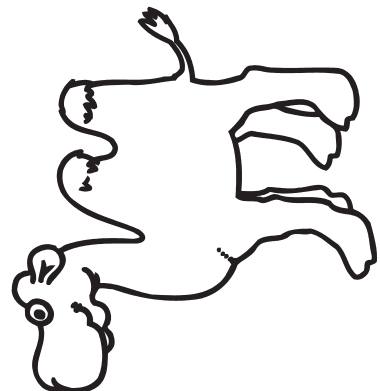
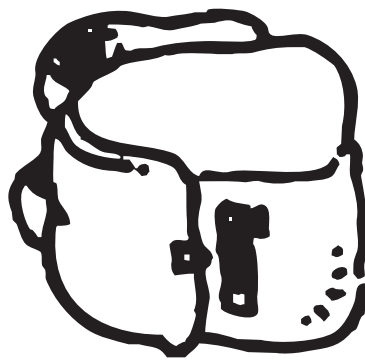
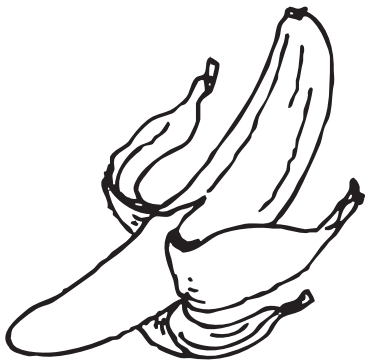
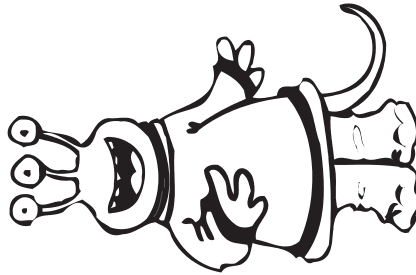
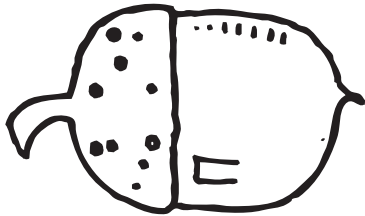

acorn, alien, beach, banana, backpack, camel

Phonics

Alphabet Memory Game

P.008

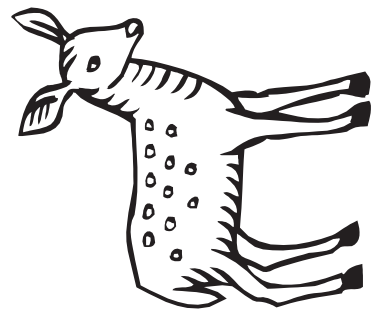
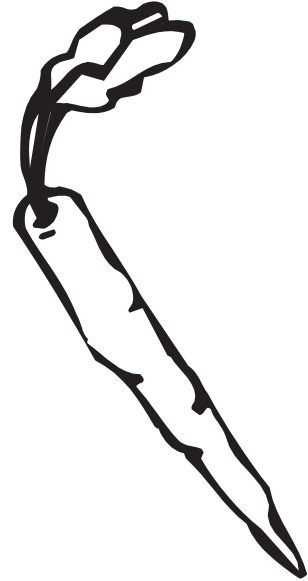
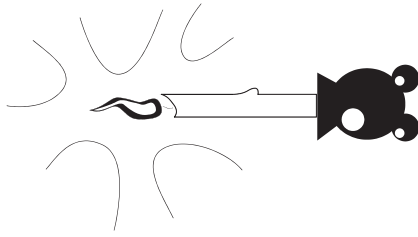

cane, candle, carrot, doughnut, dragon, deer



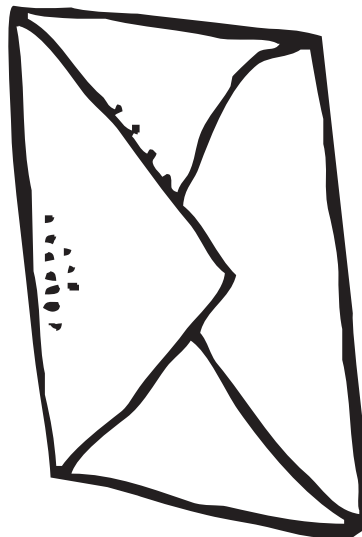
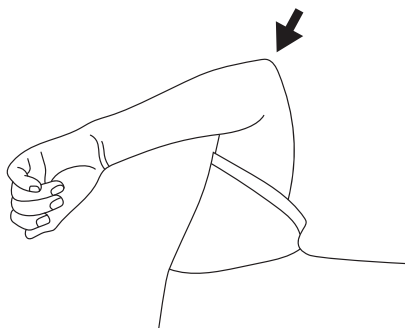
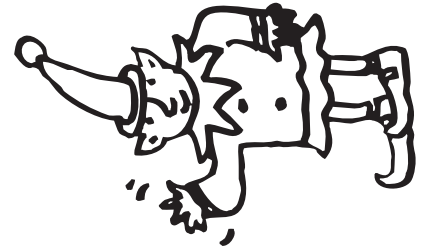
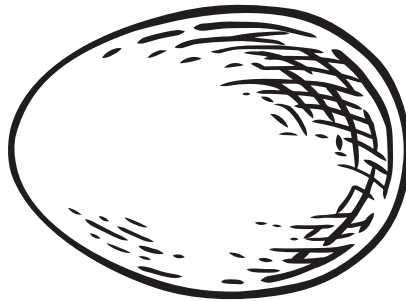
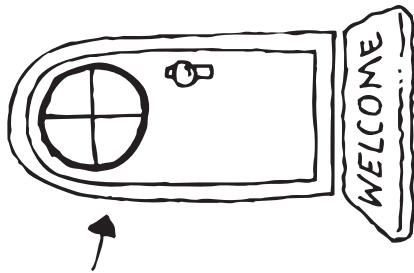

$$2 + 2 = 4$$

door, egg, elf, elbow, envelope, equal



Phonics

Alphabet Memory Game

P.008

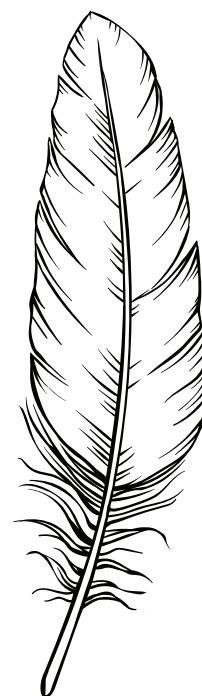
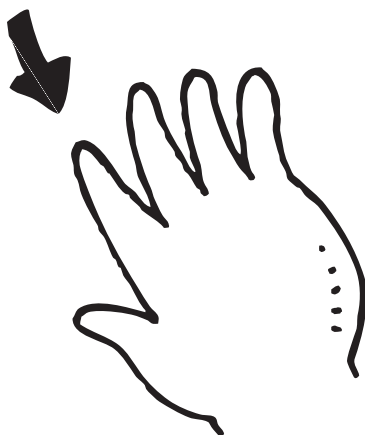
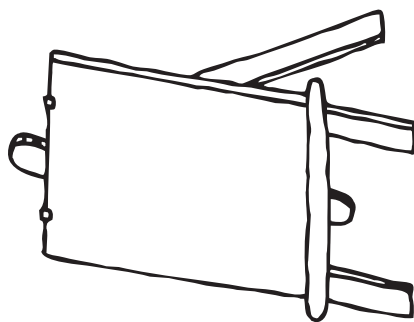

eagle, easel, eat, four, finger, feather



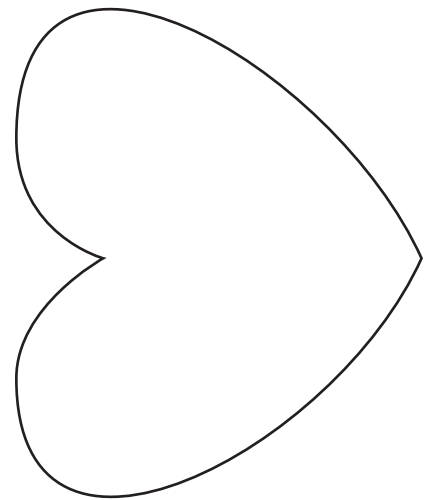
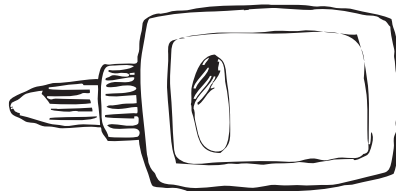
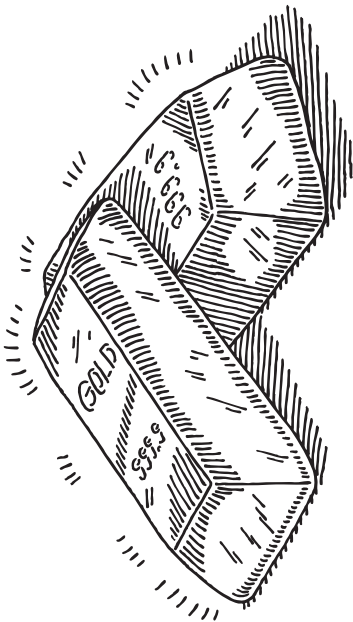
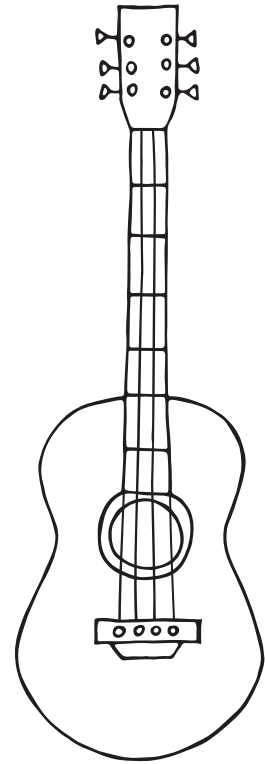
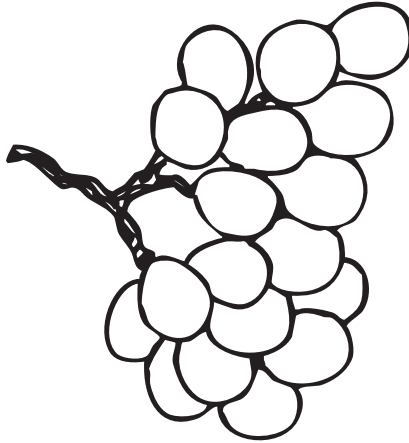
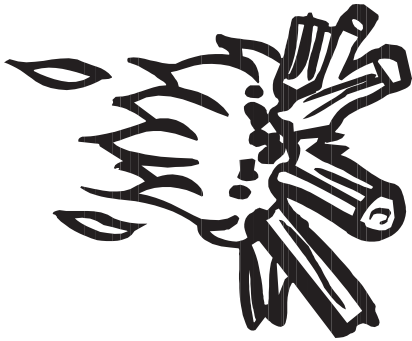

fire, grapes, guitar, gold, glue, heart



Phonics

Alphabet Memory Game

P.008

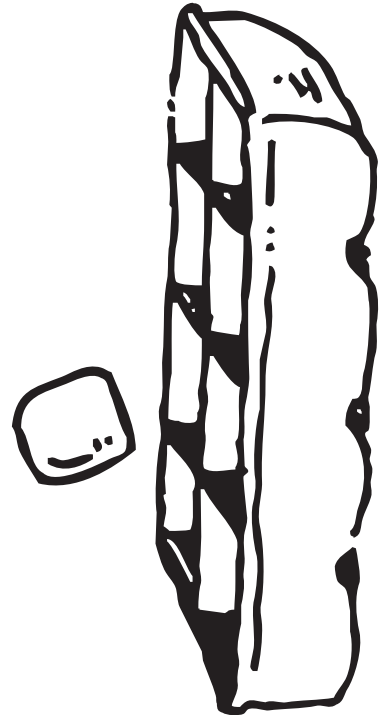
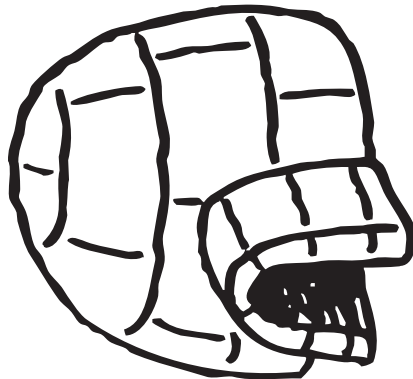
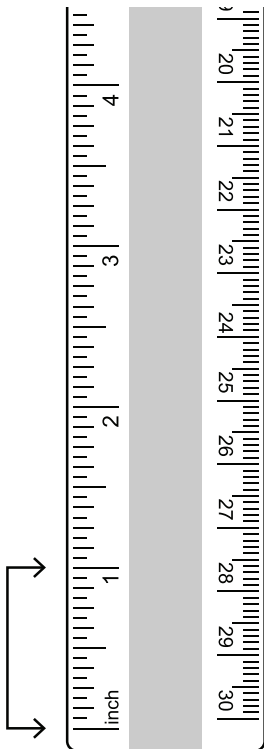
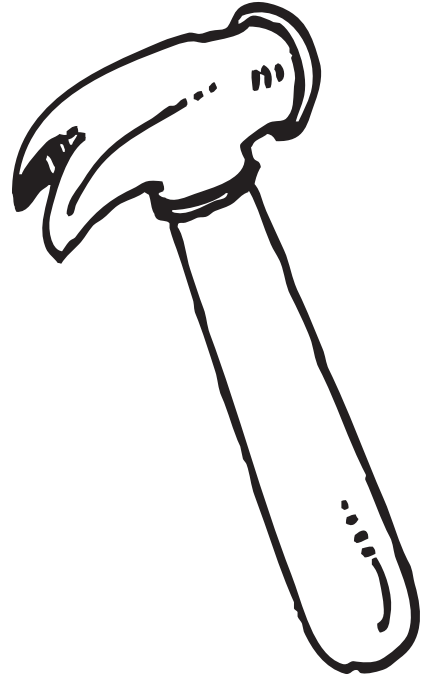

hippopotamus, horse, hammer, inch, igloo, ice



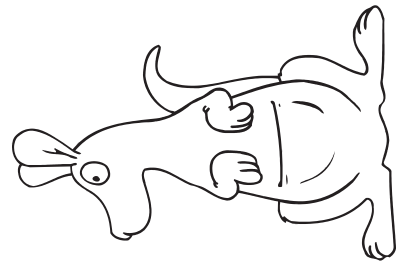
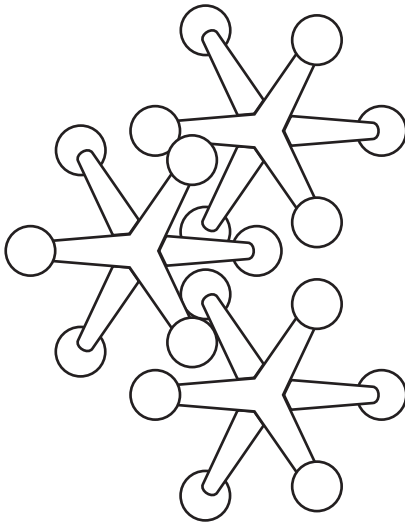
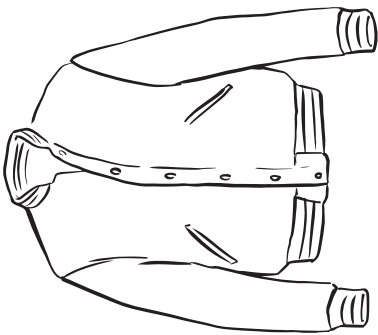
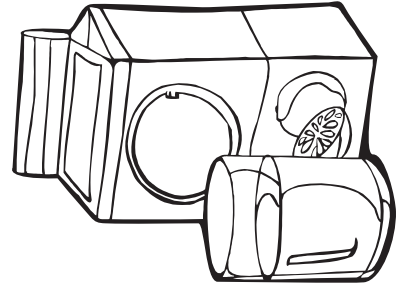
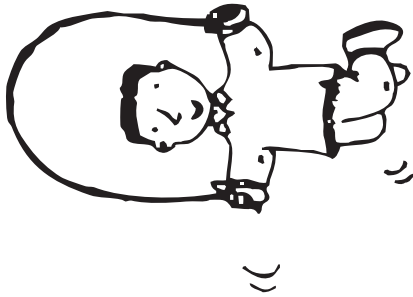
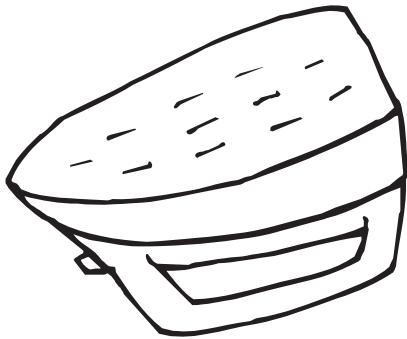

iron, jump, juice, jacket, jacks, kangaroo



Phonics

Alphabet Memory Game

P.008

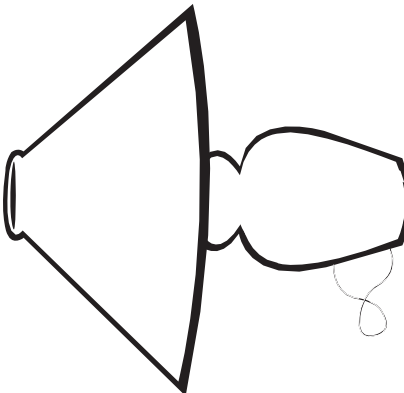
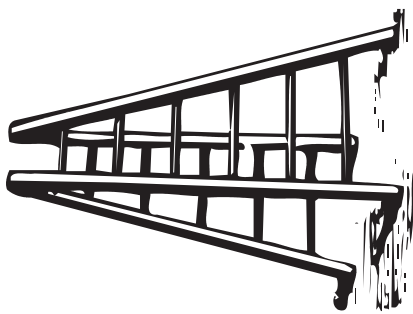
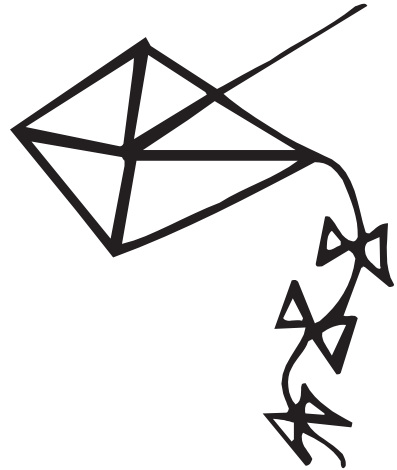
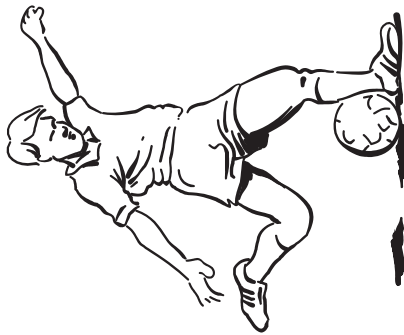

key, kick, kite, ladder, lamp, lion



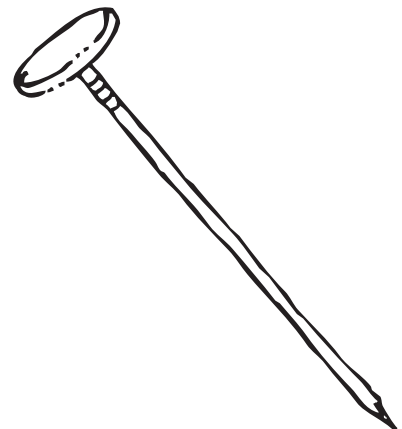
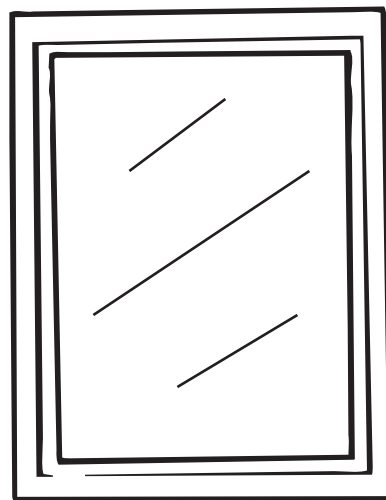
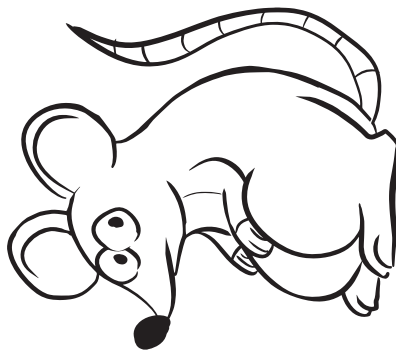
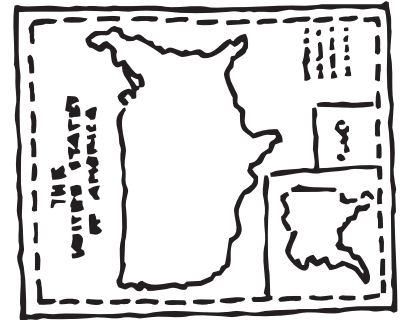
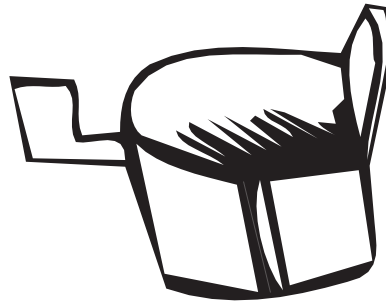
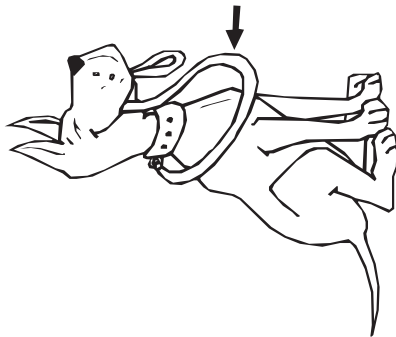

leash, mailbox, map, mouse, mirror, nail



Phonics

Alphabet Memory Game

P.008

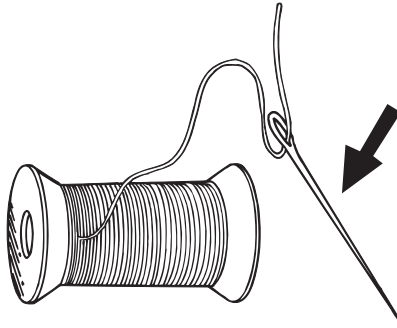
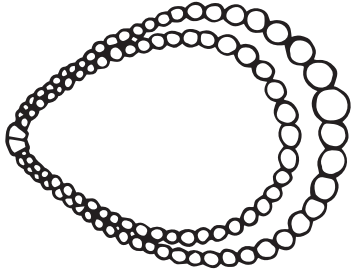

necklace, needle, nurse, octopus, ox, olive



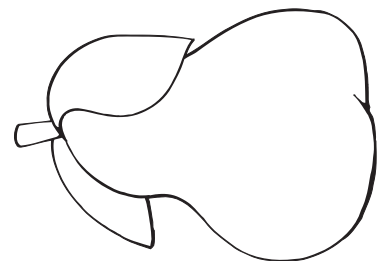
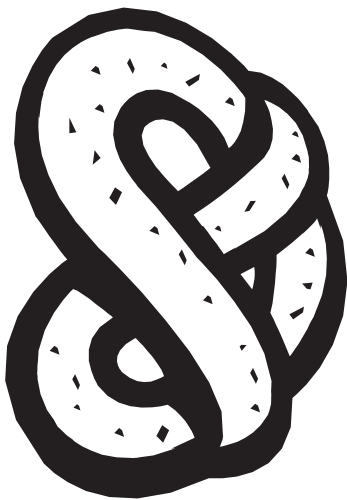
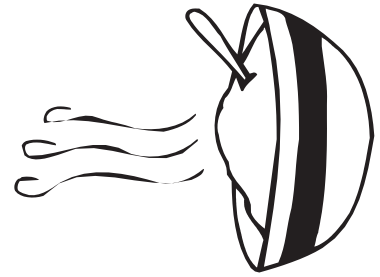
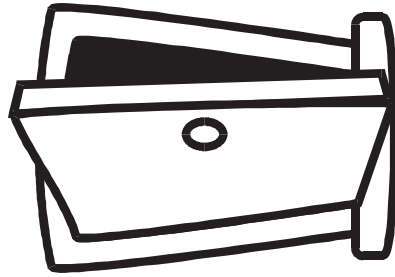

ostrich, open, oatmeal, pretzel, pillow, pear



Phonics

Alphabet Memory Game

P.008

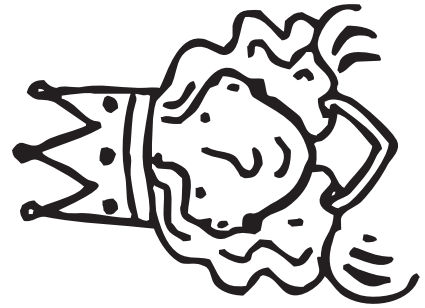
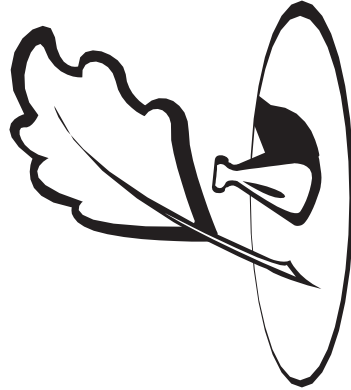
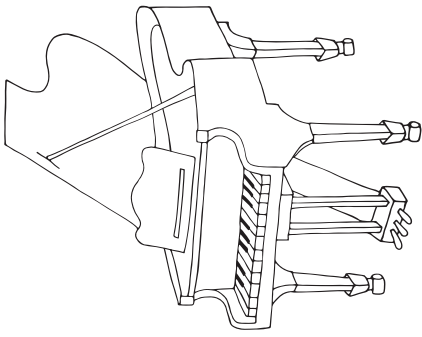

piano, quill, queen, question, quarter, rabbit



P.008

Alphabet Memory Game

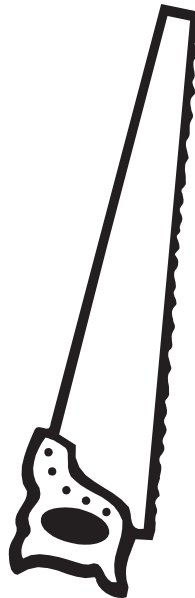
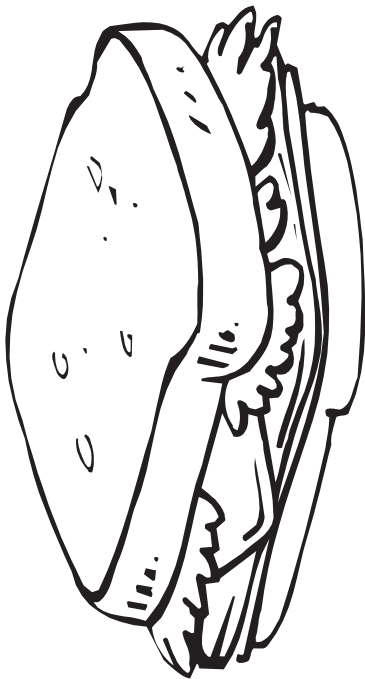
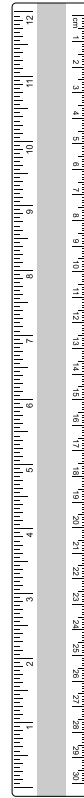
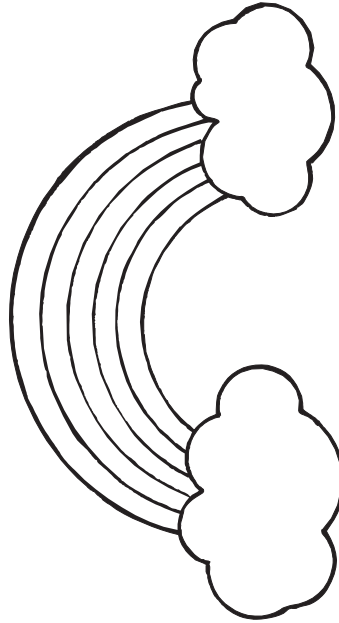
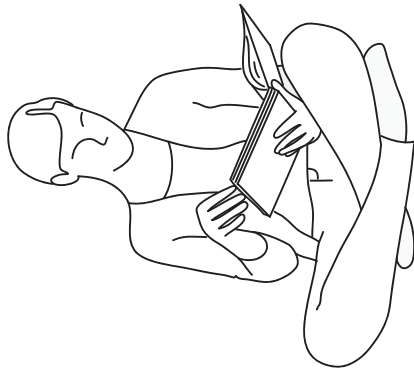

7

read, rainbow, ruler, sandwich, saw, seven

Phonics

Alphabet Memory Game

P.008

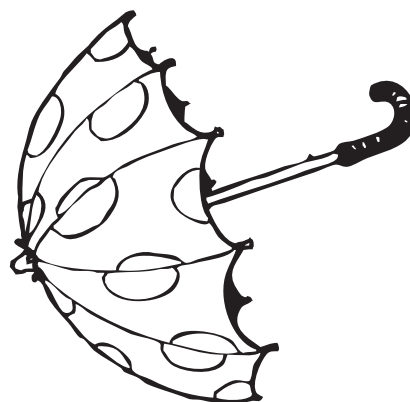
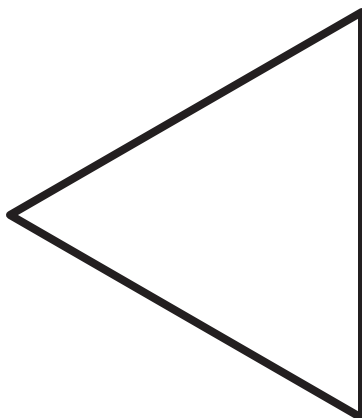
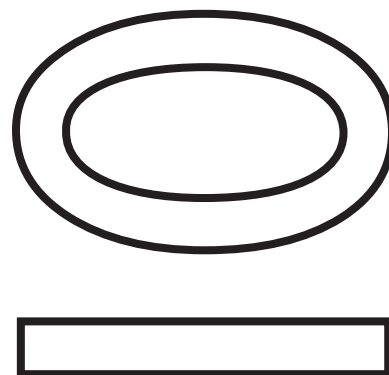
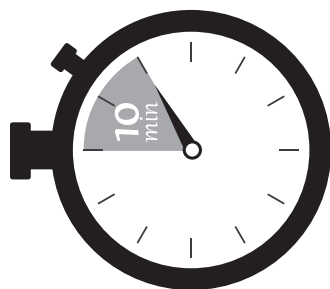

snake, timer, ten, tire, triangle, umbrella



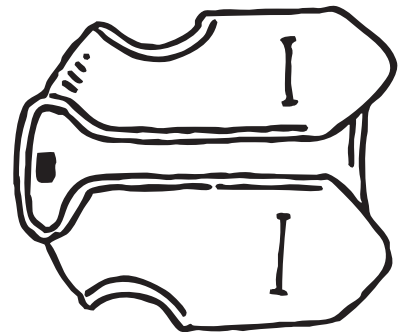
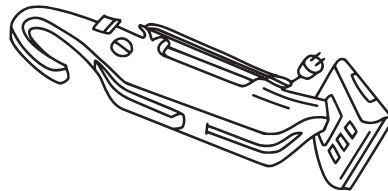
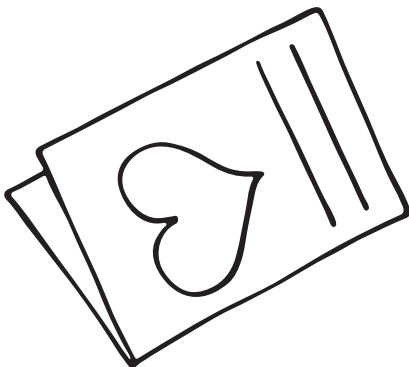
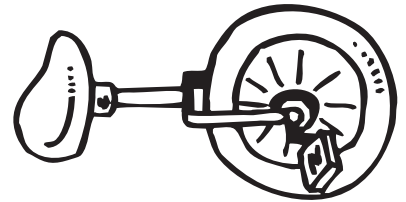
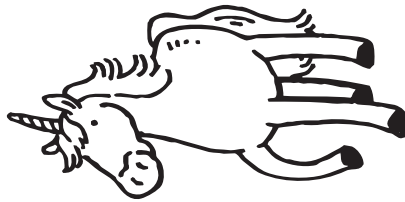

umpire, unicorn, unicycle, valentine, vacuum, vest



Phonics

Alphabet Memory Game

P.008

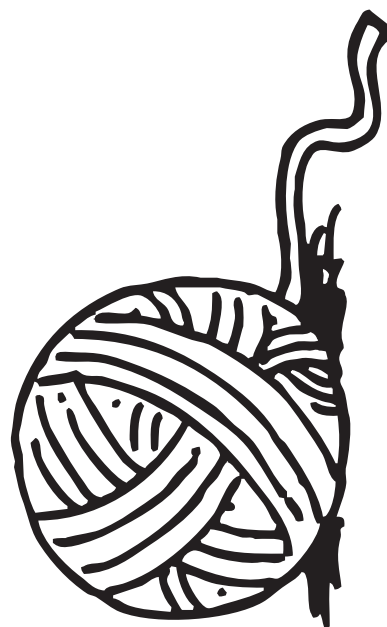
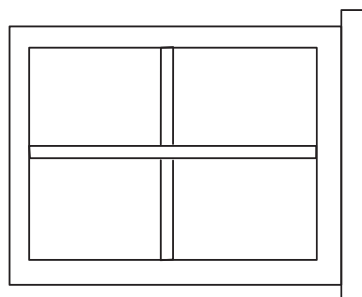
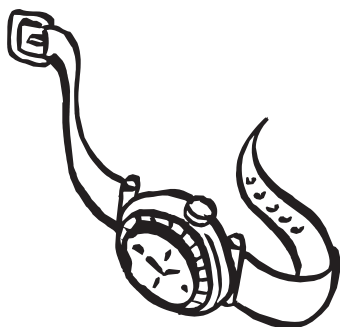
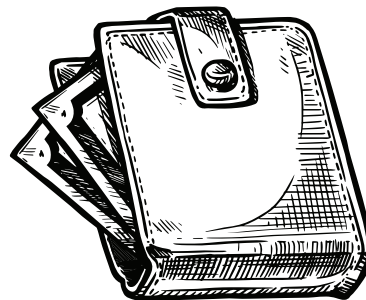
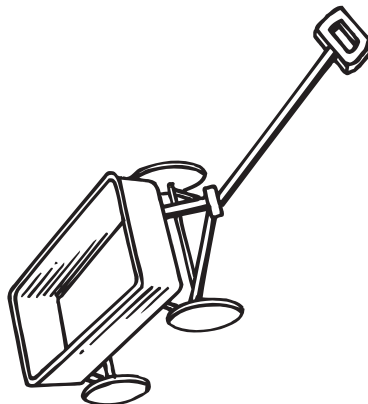
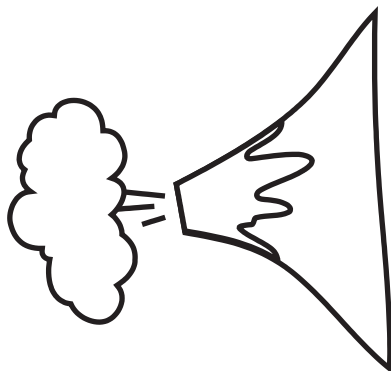

volcano, wagon, wallet, watch, window, yarn



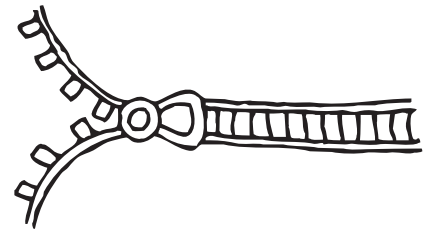
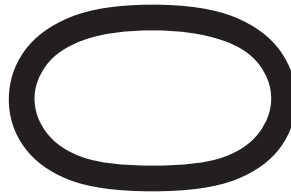
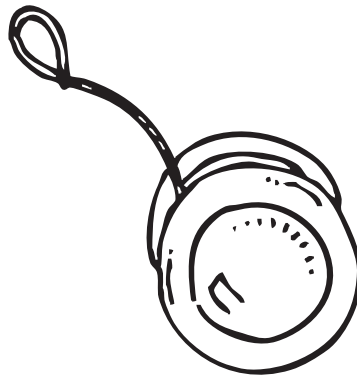

yawn, yo-yo, yak, zebra, zero, zipper



Phonics

Alphabet Memory Game

P.008

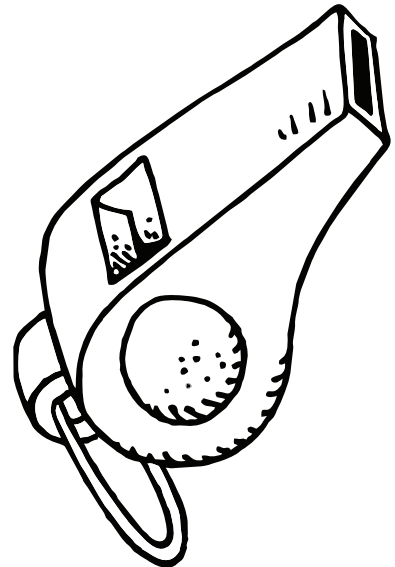
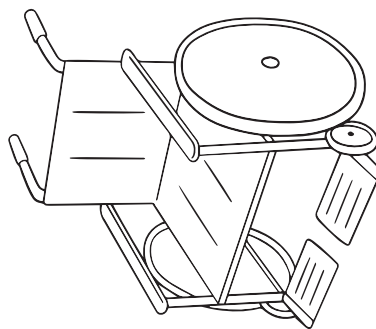
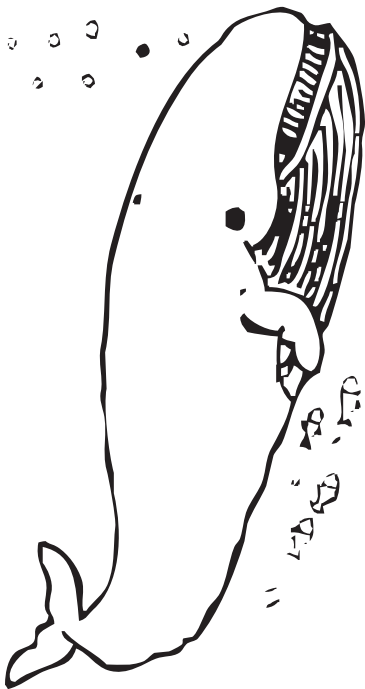
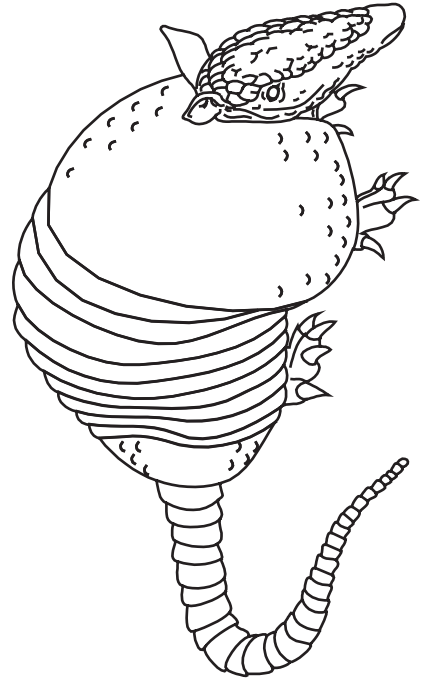
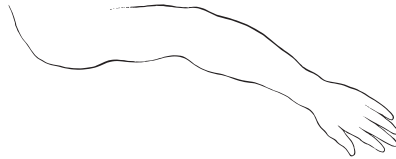

zoo, arm, armadillo, whale, wheelchair, whistle



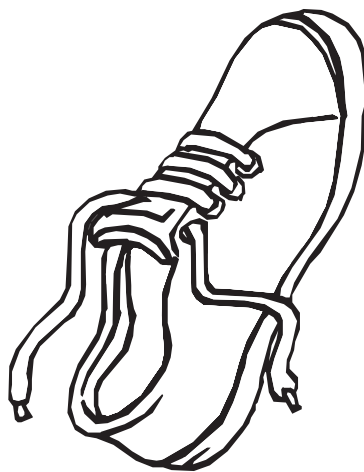
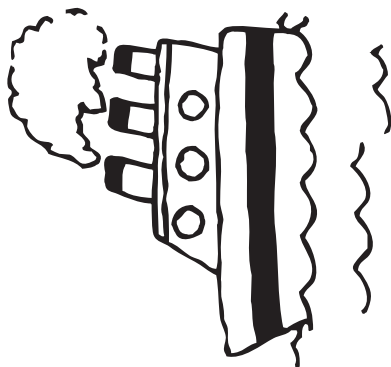
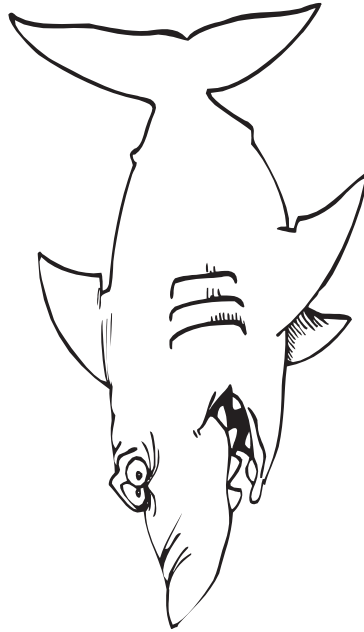
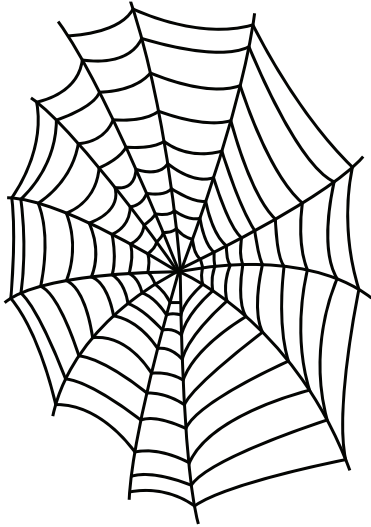

web, shark, shell, ship, shoe, thermometer



Phonics

Alphabet Memory Game

P.008

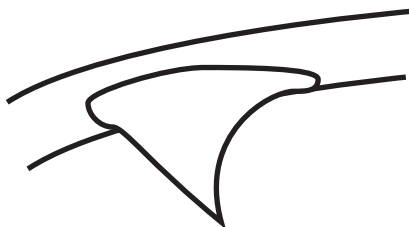
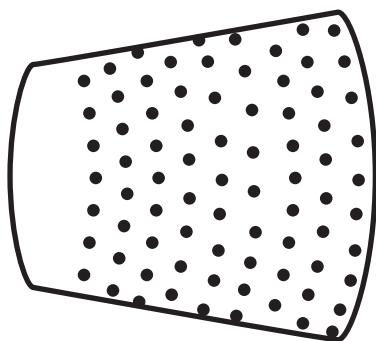

30

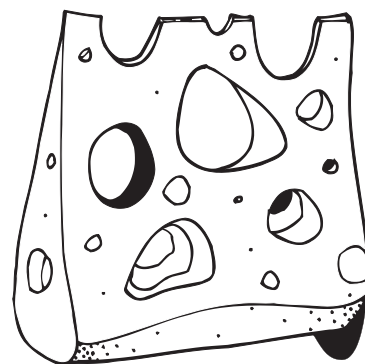
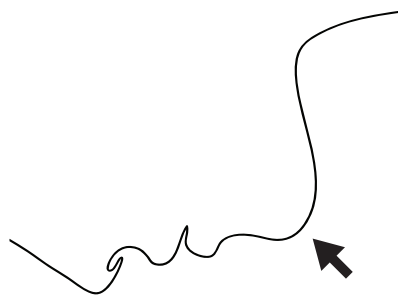
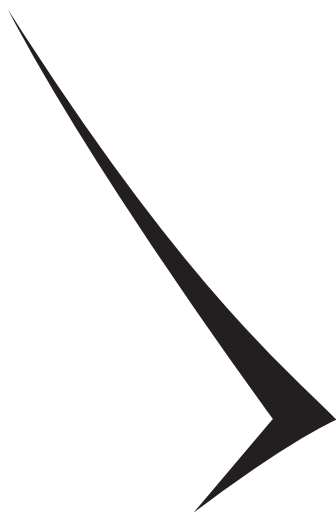

thimble, thorn, thirty, check, chin, cheese



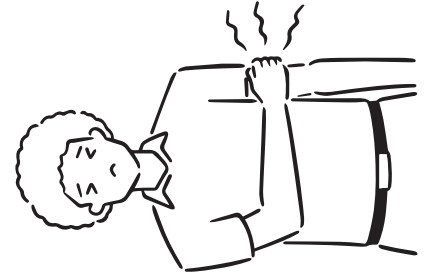
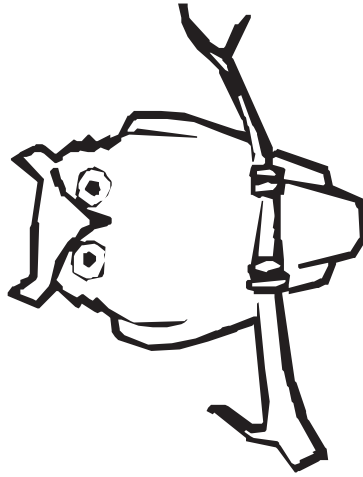
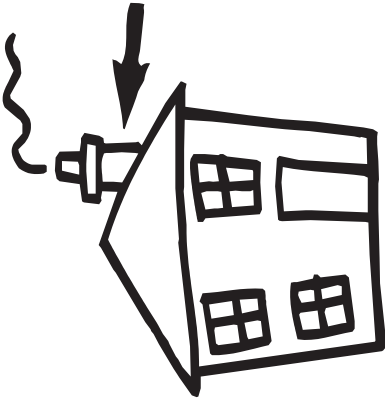

chimney, owl, ouch

