



Words Around Us Memory Game

Objective

The student will match initial phonemes to graphemes.

Materials

- ▶ Initial sound picture cards
Choose eight-to-ten target initial sound picture cards.
- ▶ Uppercase or lowercase letter cards
Choose letter cards that correspond to the initial sound for each target picture card.

Activity

Students pair initial sound picture cards with the corresponding letter while playing a memory game.

1. Place picture cards and letters cards face down in separate rows.
2. Taking turns, students select two cards, name the letter (e.g., “v”) or name the picture, and say its initial sound (e.g., “vacuum, /v/”).
3. Determine if there is a letter-sound match. If there is a match (e.g., “v, /v/”) pick up the cards, place to the side and take another turn. If cards do not match (e.g., “v, /b/”), or if two letter cards or two picture cards are selected, return to their original places, and allow partner to take a turn.
4. Continue until all letter-sound pairs are made.
5. Peer evaluation

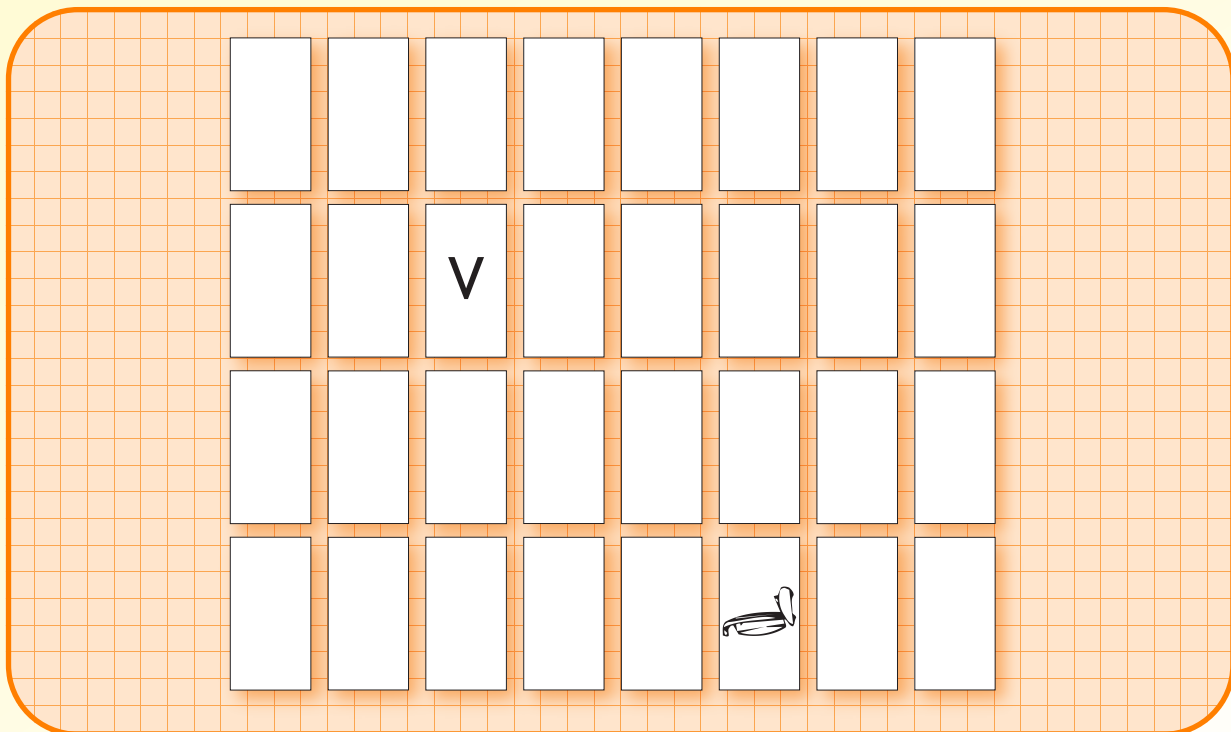

Extensions and Adaptations

- ▶ Put the pictures and cards in alphabetical order.
- ▶ Match cards by final sound.
- ▶ Match cards by number of syllables.
- ▶ Match cards by number of phonemes.

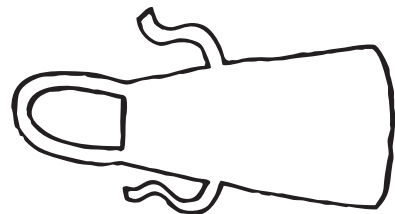
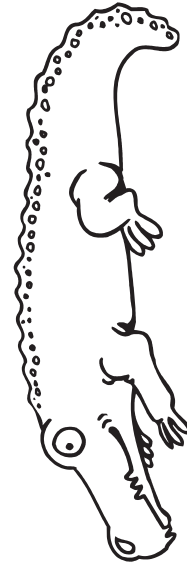
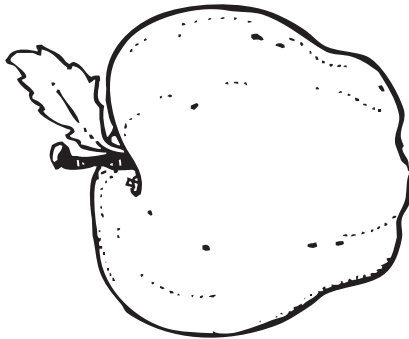
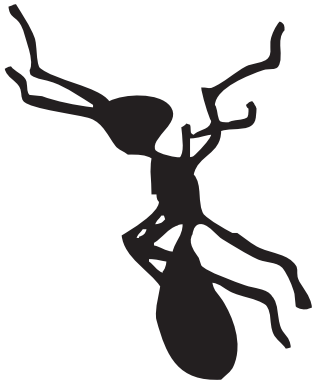

ant, apple, alligator, ax, ape, apron

Phonics

P.015

Words Around Us Memory Game

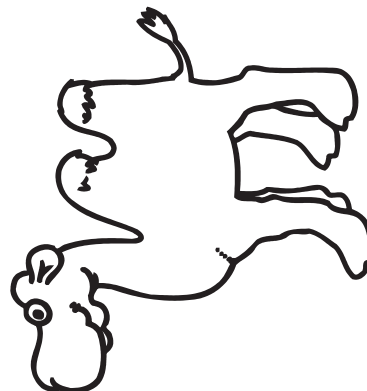
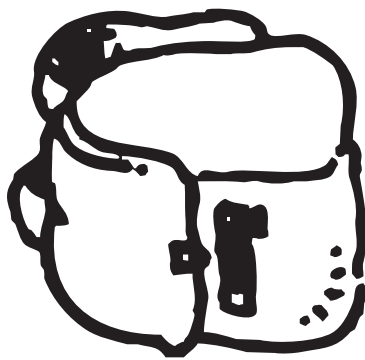
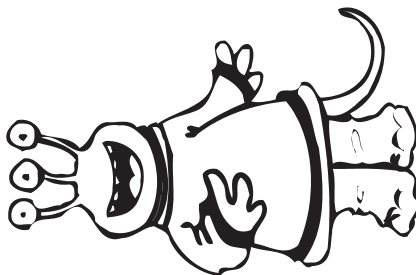
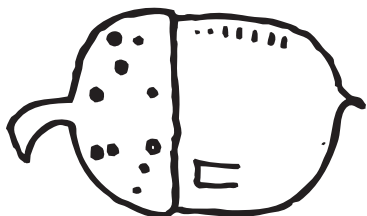

acorn, alien, beach, banana, backpack, camel

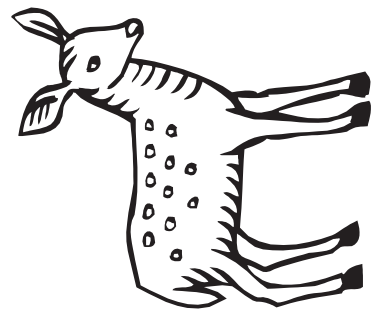
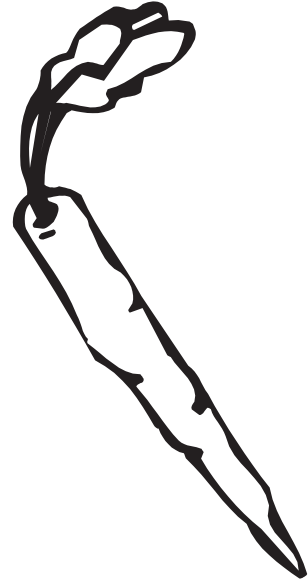
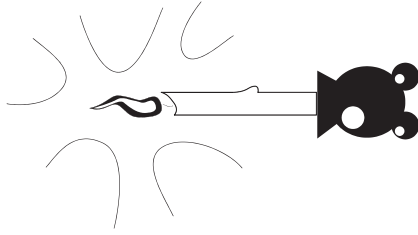

cane, candle, carrot, doughnut, dragon, deer



Phonics

P.015

Words Around Us Memory Game

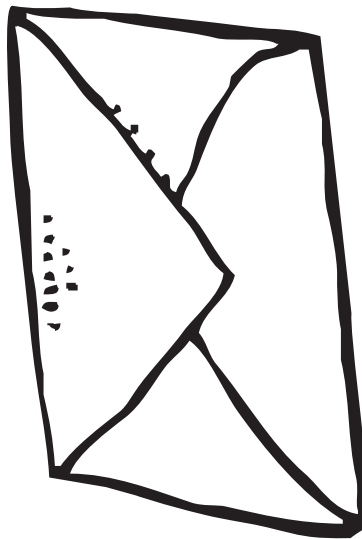
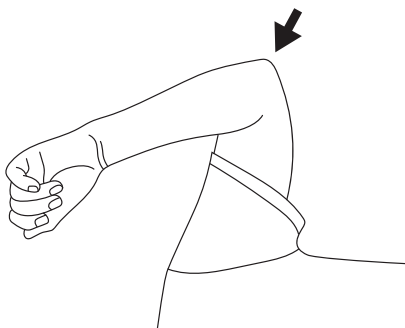
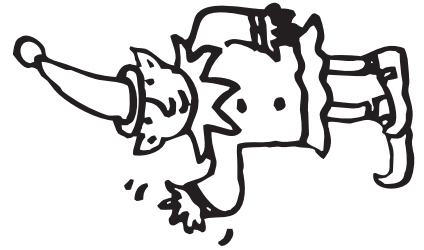
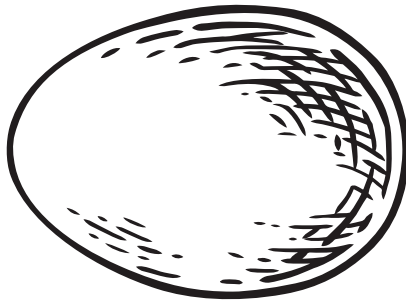
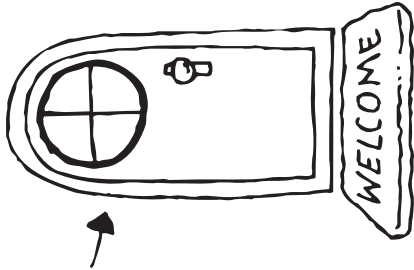

$$2 + 2 = 4$$

An arrow points to the equals sign in the equation.

door, egg, elf, elbow, envelope, equal



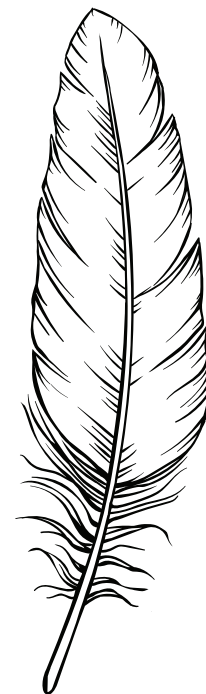
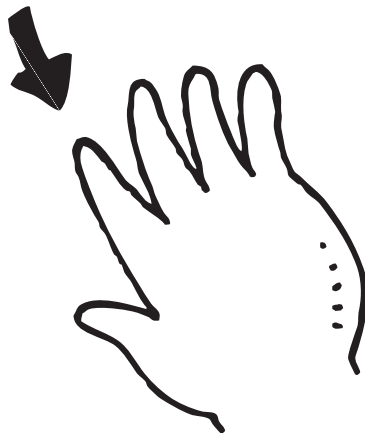
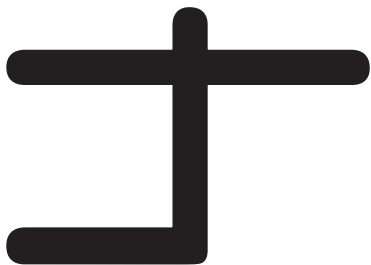
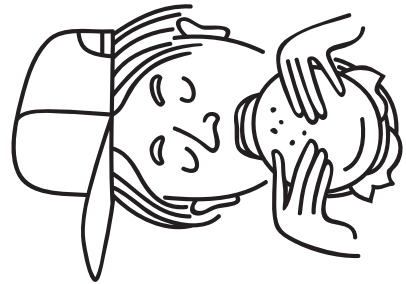
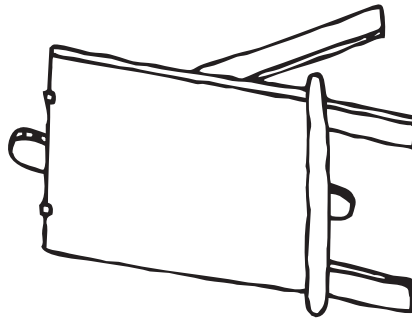

eagle, easel, eat, four, finger, feather



Phonics

P.015

Words Around Us Memory Game

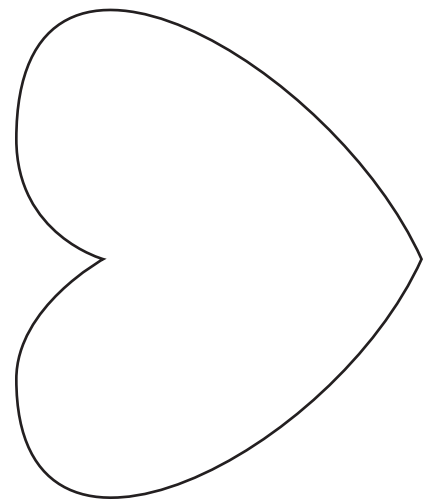
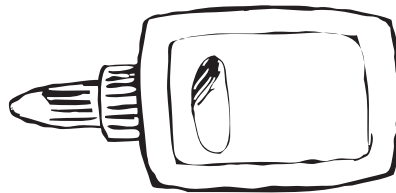
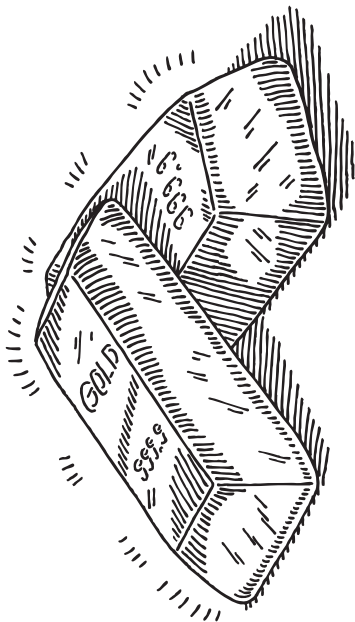
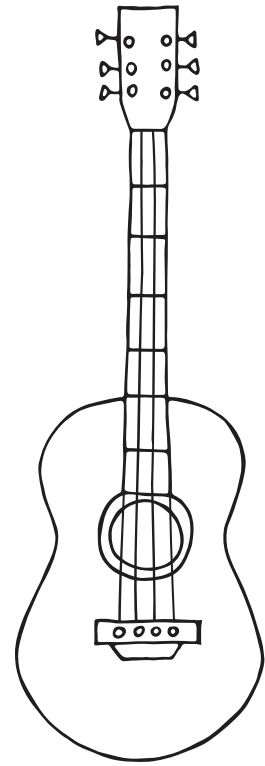
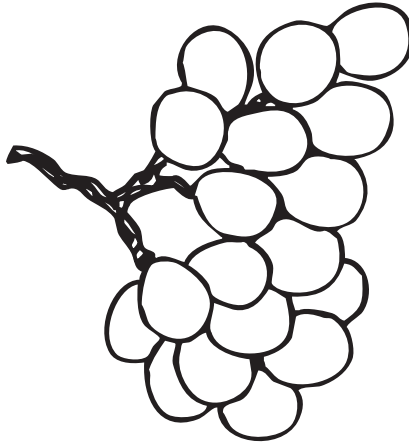
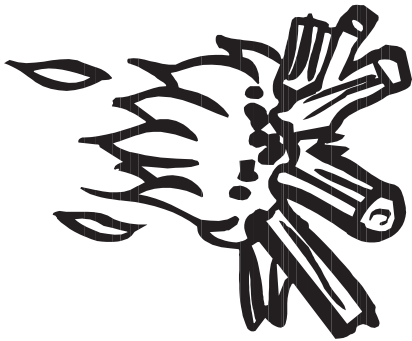

fire, grapes, guitar, gold, glue, heart



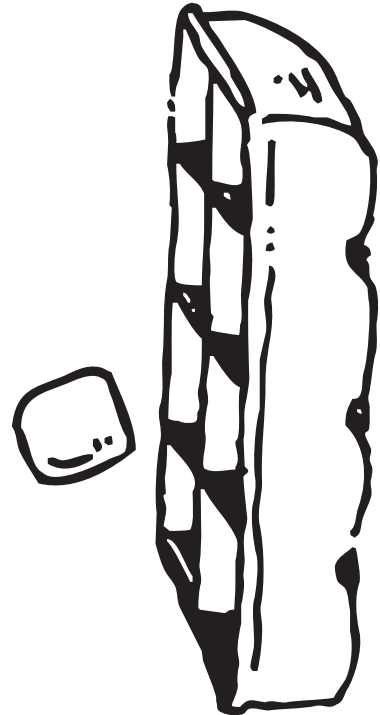
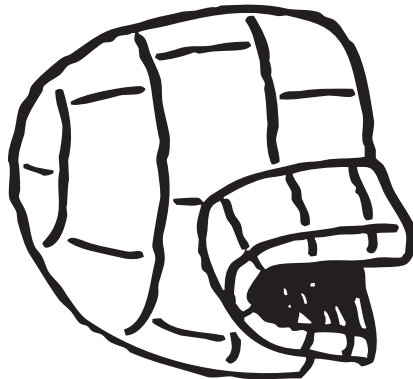
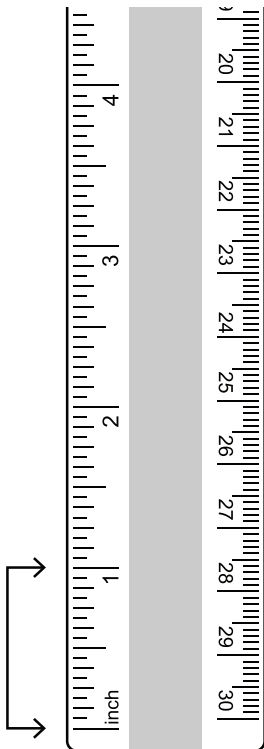
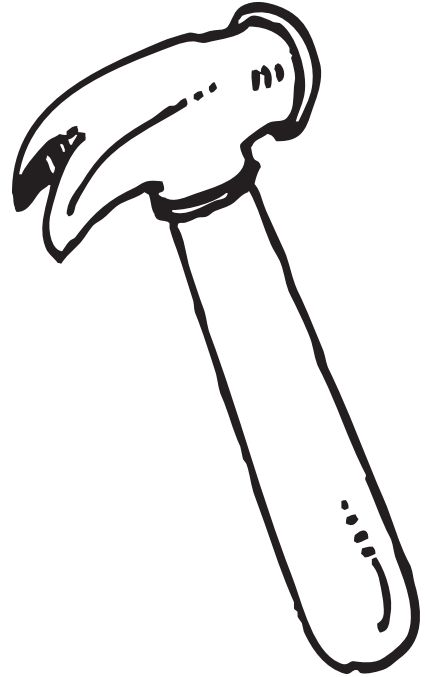
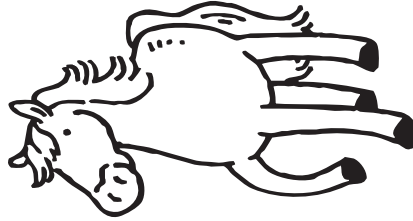

hippopotamus, horse, hammer, inch, igloo, ice



Phonics

P.015

Words Around Us Memory Game

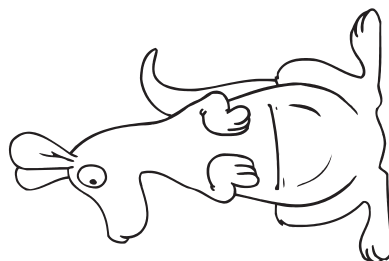
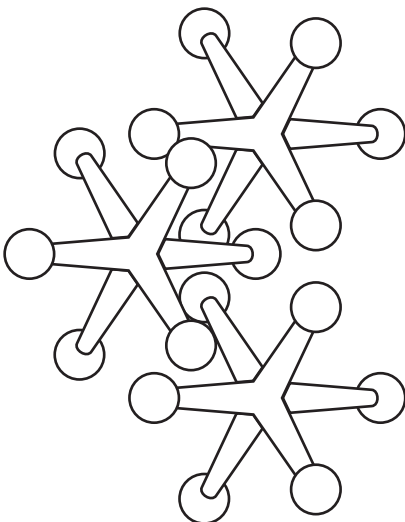
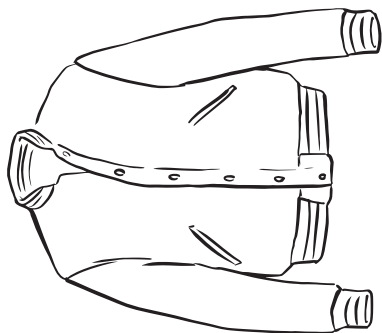
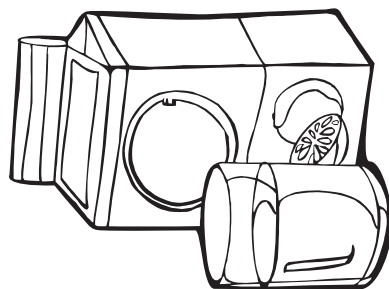
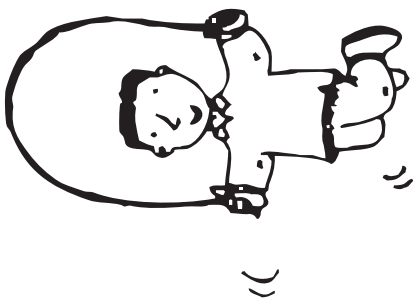
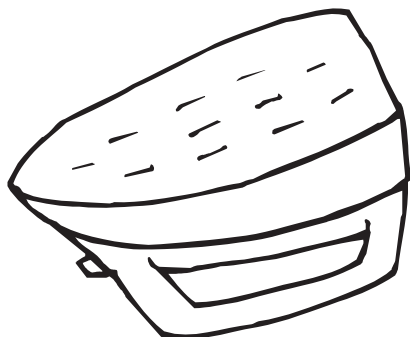

iron, jump, juice, jacket, jacks, kangaroo



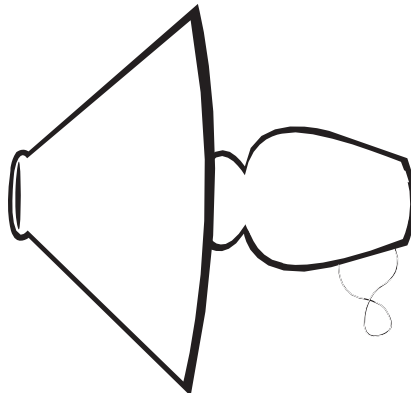
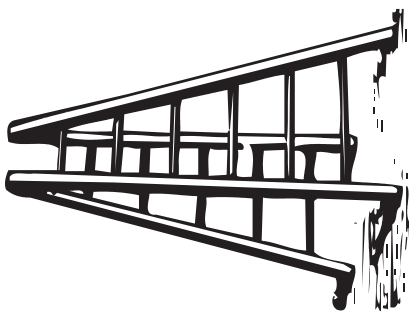
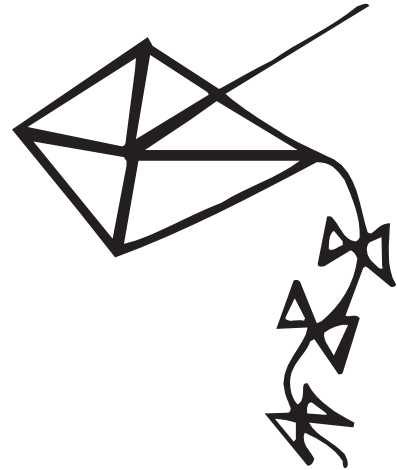
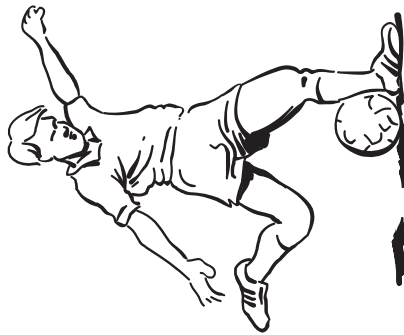

key, kick, kite, ladder, lamp, lion



Phonics

P.015

Words Around Us Memory Game

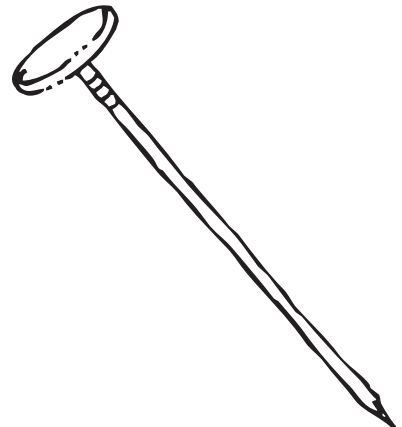
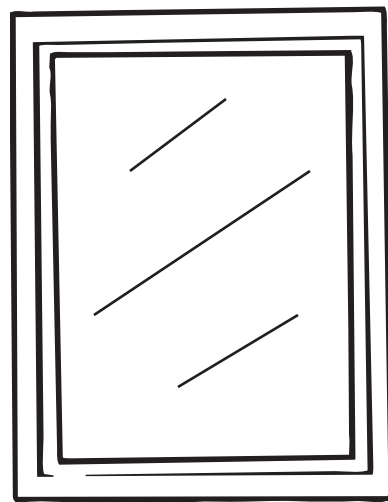
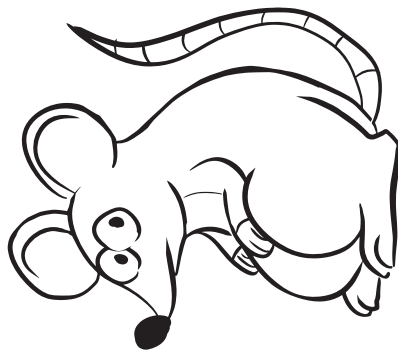
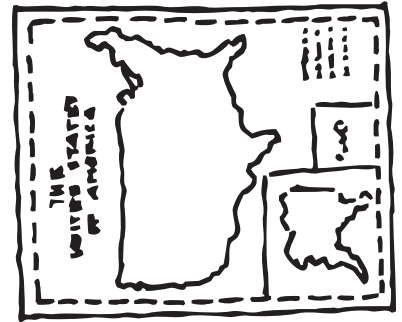
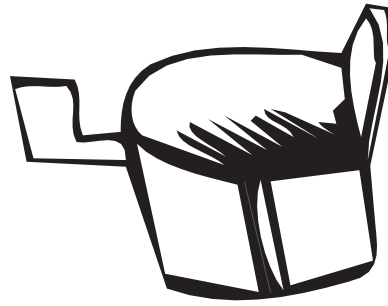
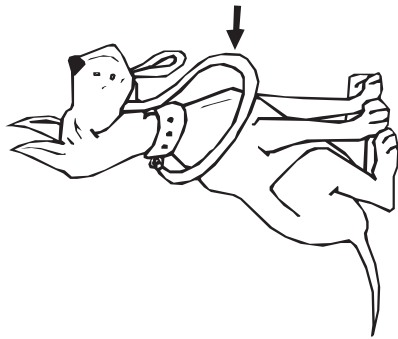

leash, mailbox, map, mouse, mirror, nail



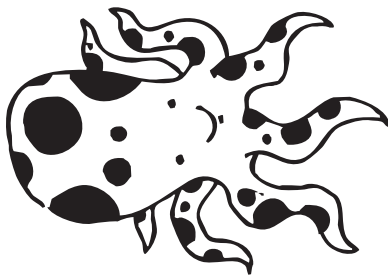
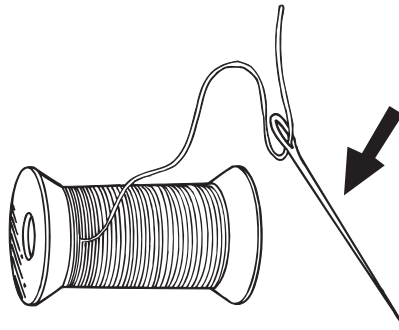
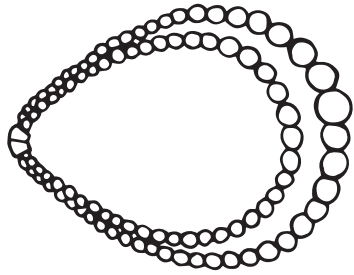

necklace, needle, nurse, octopus, ox, olive



Phonics

P.015

Words Around Us Memory Game

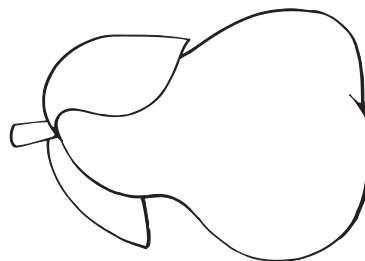
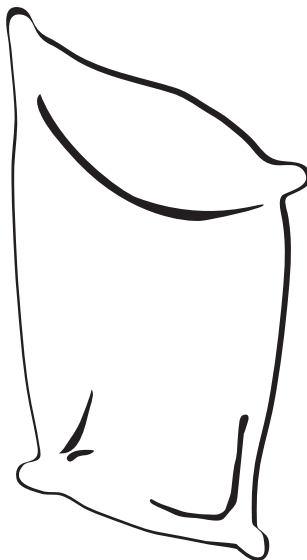
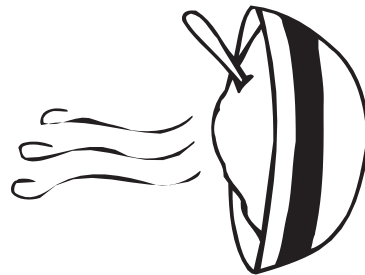
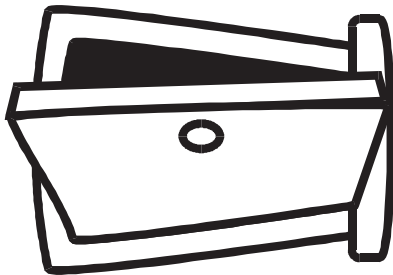

ostrich, open, oatmeal, pretzel, pillow, pear



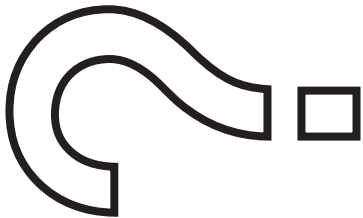
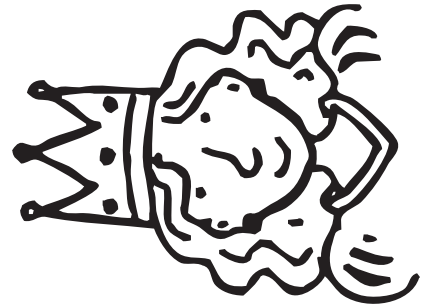
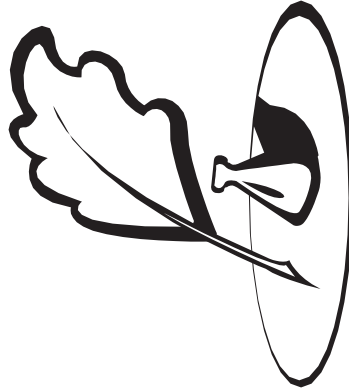
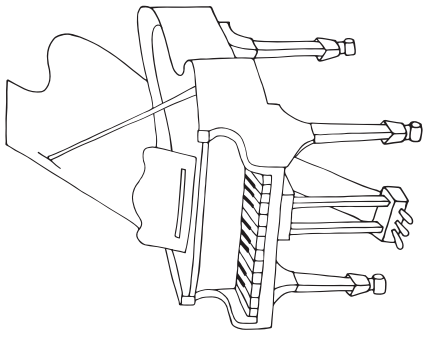

piano, quill, queen, question, quarter, rabbit



Phonics

P.015

Words Around Us Memory Game

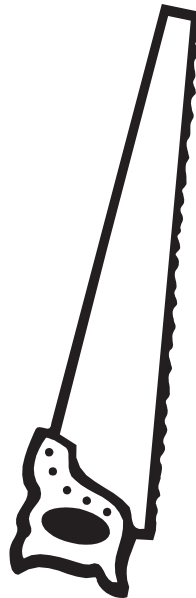
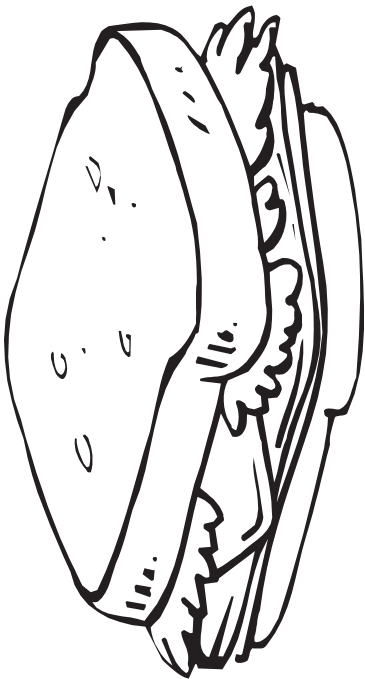
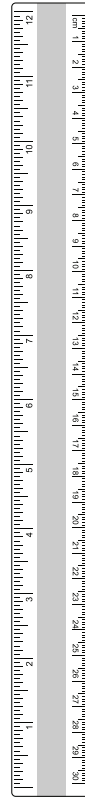
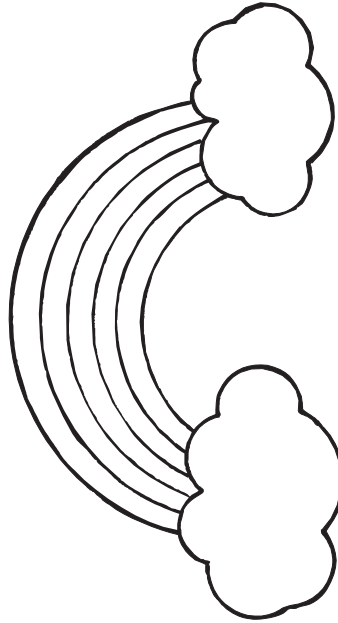
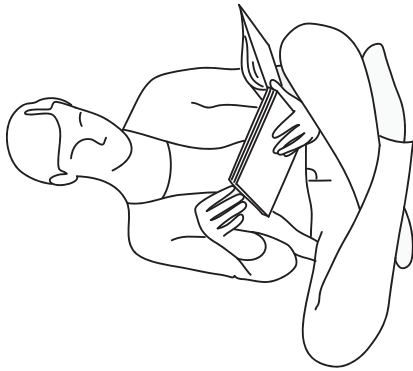

7

read, rainbow, ruler, sandwich, saw, seven

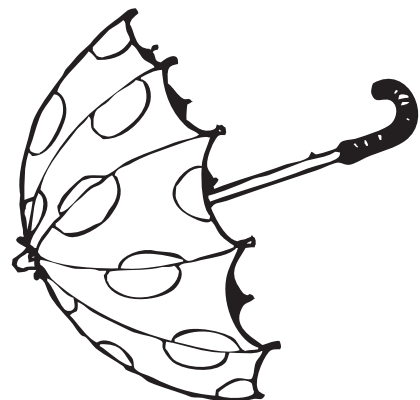
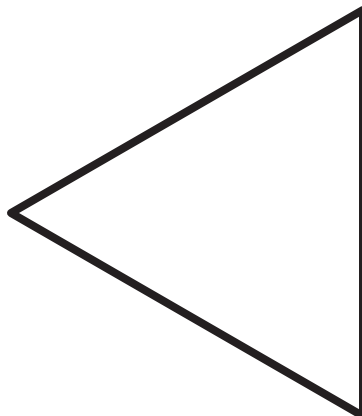
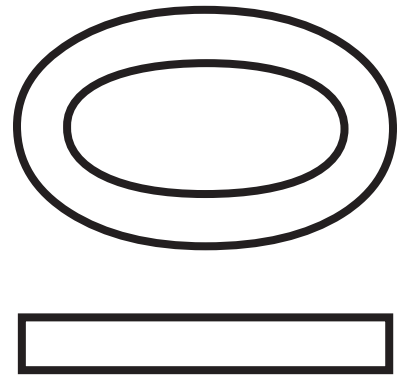
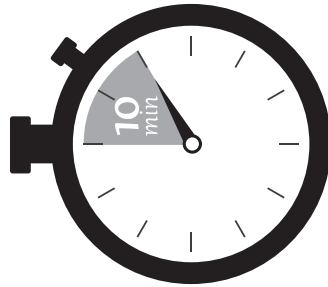

snake, timer, ten, tire, triangle, umbrella



Phonics

P.015

Words Around Us Memory Game

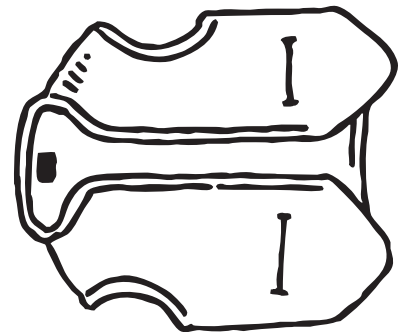
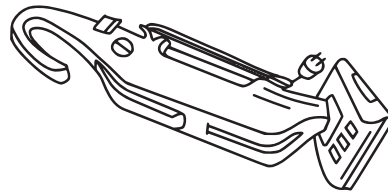
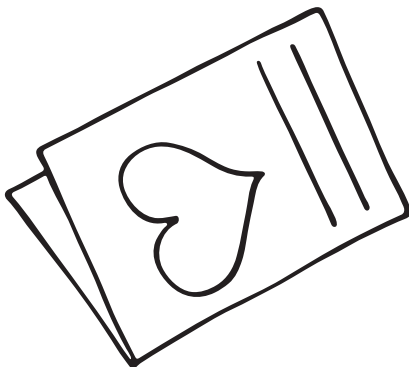
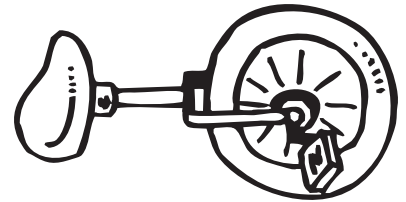
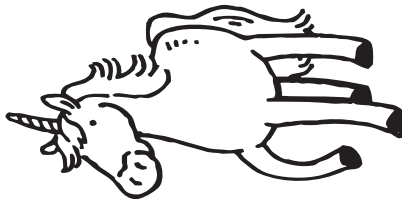

umpire, unicorn, unicycle, valentine, vacuum, vest



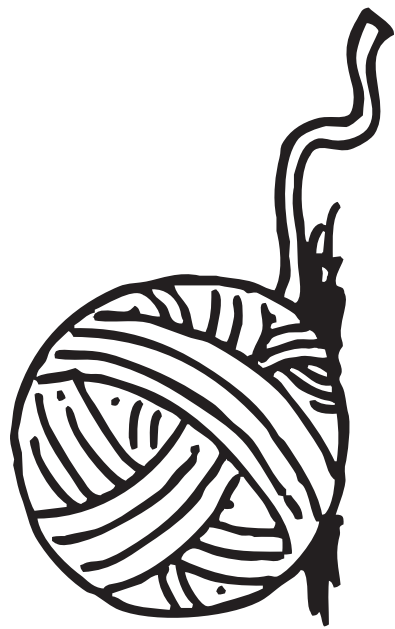
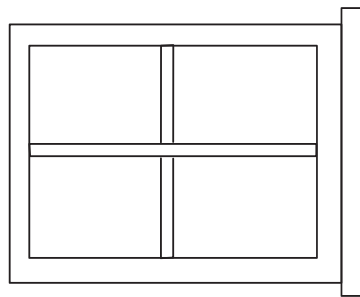
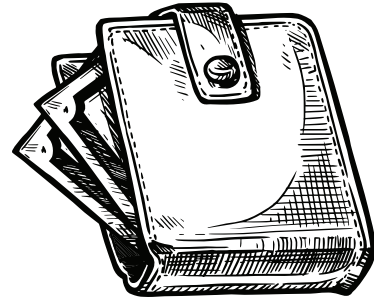
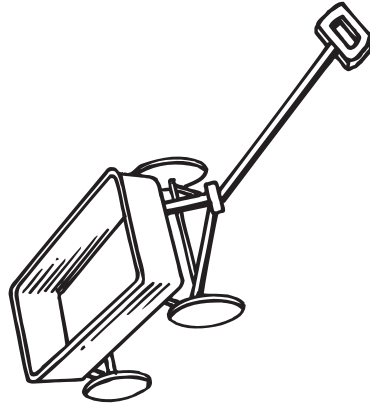
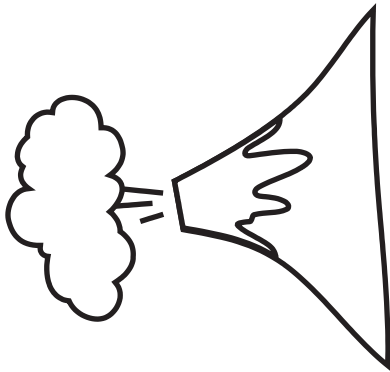

volcano, wagon, wallet, watch, window, yarn



Phonics

P.015

Words Around Us Memory Game

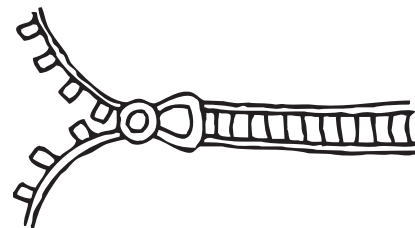
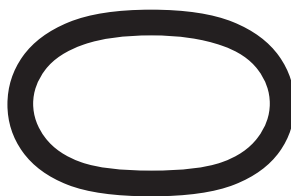

yawn, yo-yo, yak, zebra, zero, zipper



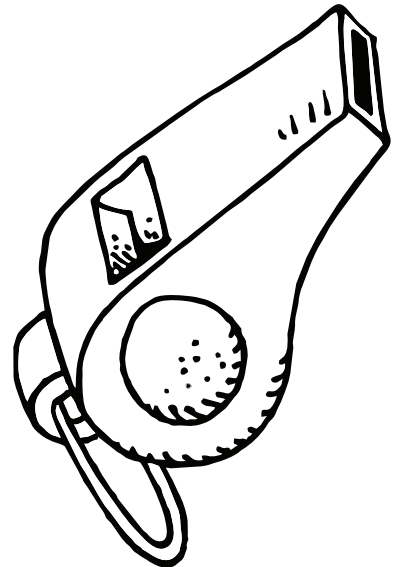
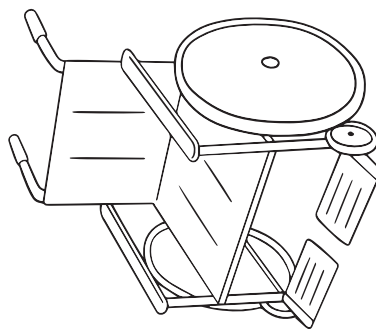
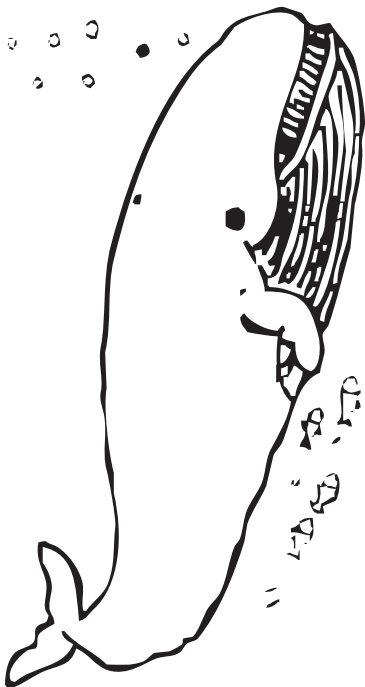
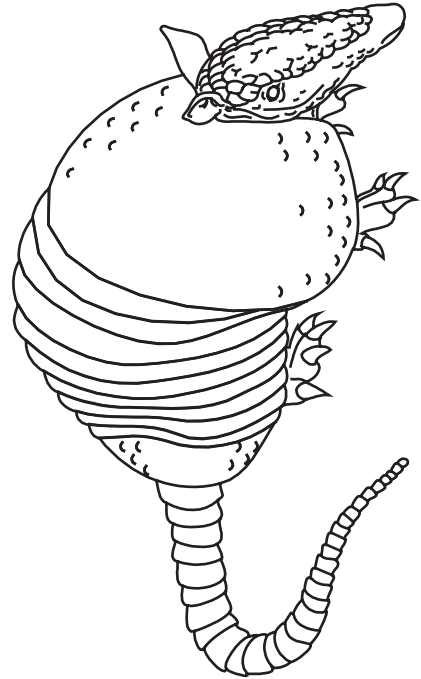
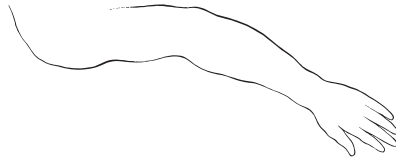

zoo, arm, armadillo, whale, wheelchair, whistle



Phonics

P.015

Words Around Us Memory Game

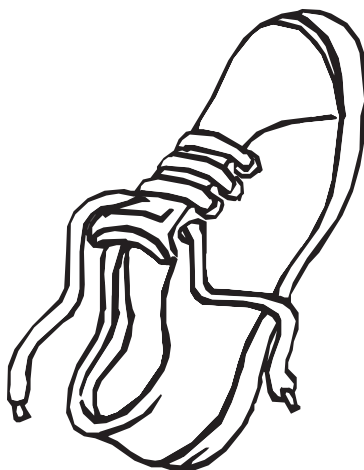
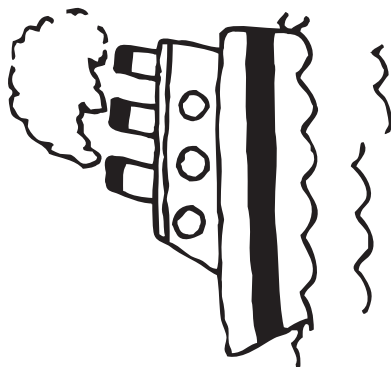
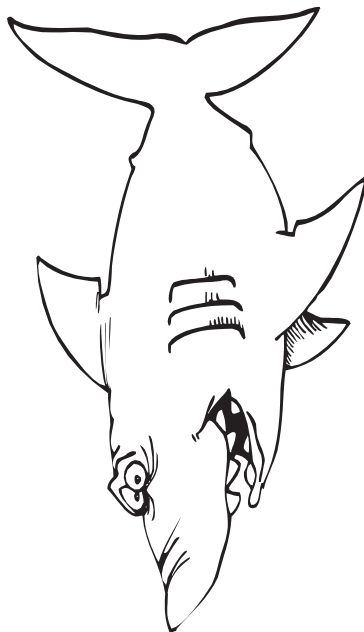
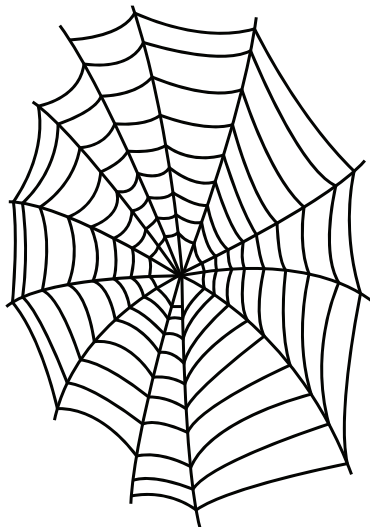

web, shark, shell, ship, shoe, thermometer



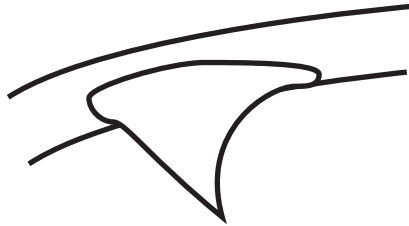
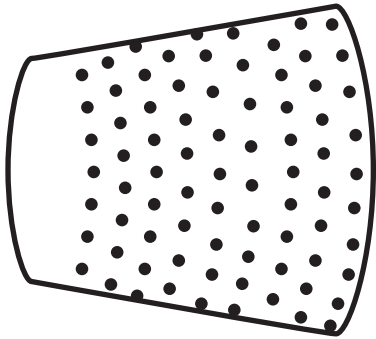

30

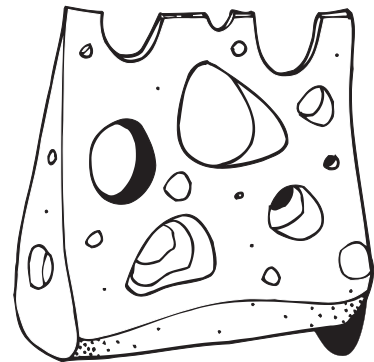
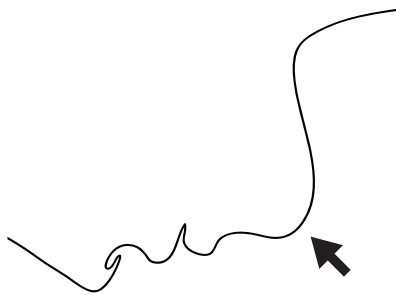
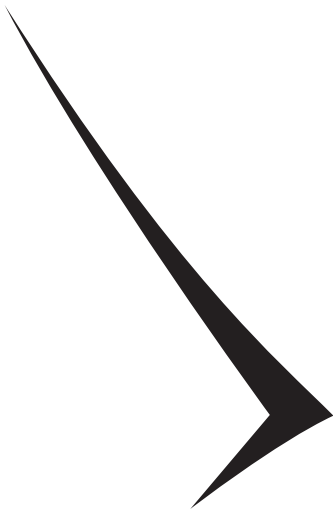

thimble, thorn, thirty, check, chin, cheese



Phonics

P.015

Words Around Us Memory Game

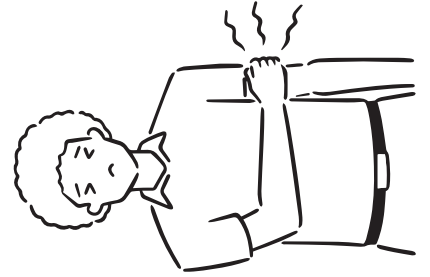
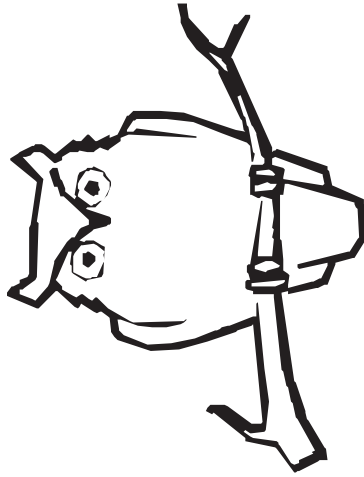
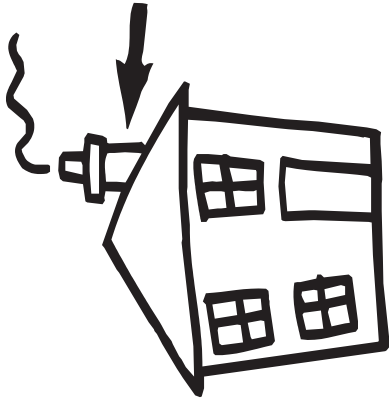

chimney, owl, ouch



A

B

C

D

E

F

G

H

I

letter cards



Phonics

P.015

Words Around Us Memory Game

J

K

L

M

N

O

P

Q

R

letter cards



S

T

U

V

W

X

Y

Z

a

letter cards



Phonics

P.015

Words Around Us Memory Game

b

c

d

e

f

g

h

i

j

letter cards



k

l

m

n

o

p

q

r

s

letter cards



Phonics

P.015

Words Around Us Memory Game

t

u

v

w

x

y

z

letter cards

