



Letter-Sound Pyramid

Objective

The student will match final phonemes to graphemes.

Materials

- ▶ Letter-Sound Pyramid triangles
Note: There are two triangles marked "A" and "B."
- ▶ Final sound picture cards
- ▶ Game pieces (e.g., counters)

Activity

Students match final sounds of words to letters while playing a pyramid game.

1. Place final sound picture cards face down in a stack. Provide each student with a different triangle and game pieces.
2. Taking turns, students select the top card from the stack, name the picture and say its final sound (e.g., "shovel, /l/").
3. Look for letter on triangle that corresponds to final sound (i.e., "l").
4. If letter is found, place game piece on that spot and place picture card in a discard pile. If no letter is found which matches, place picture card at the bottom of the stack.
5. Continue until all matches are made.
6. Peer evaluation

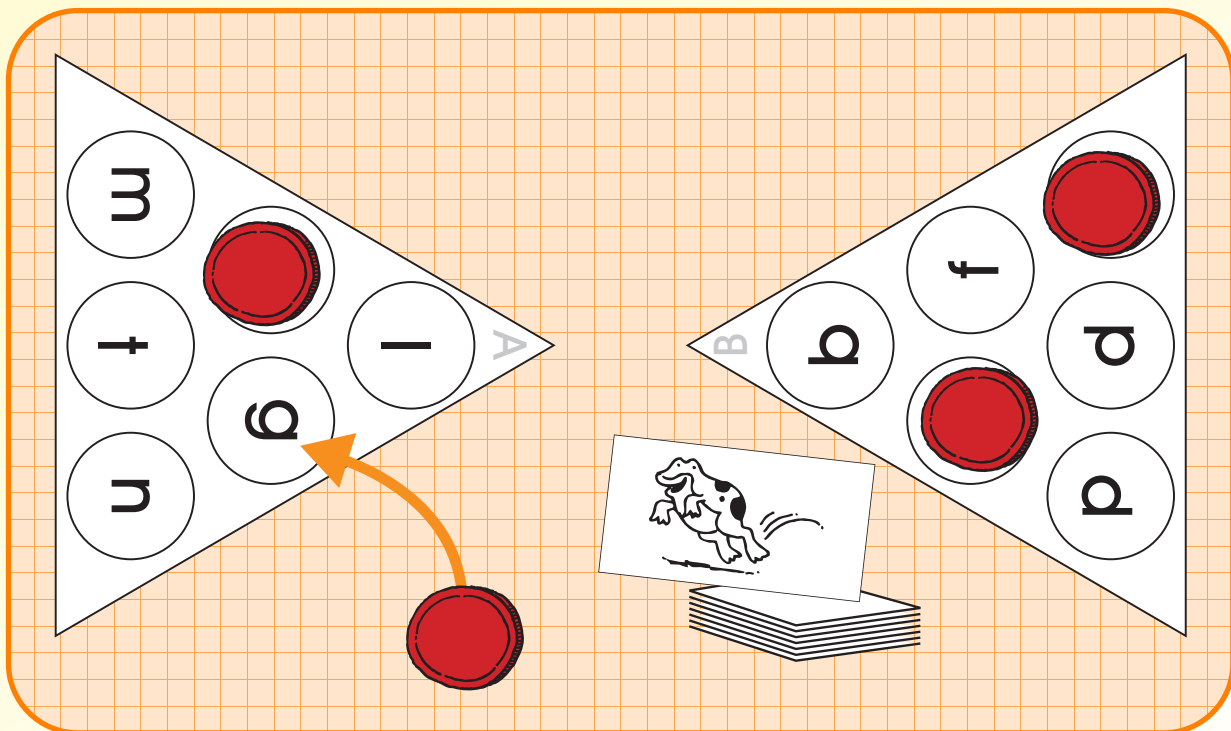

Extensions and Adaptations

- ▶ Use other triangles and picture cards.
- ▶ Make other triangles for use with initial or medial sounds.

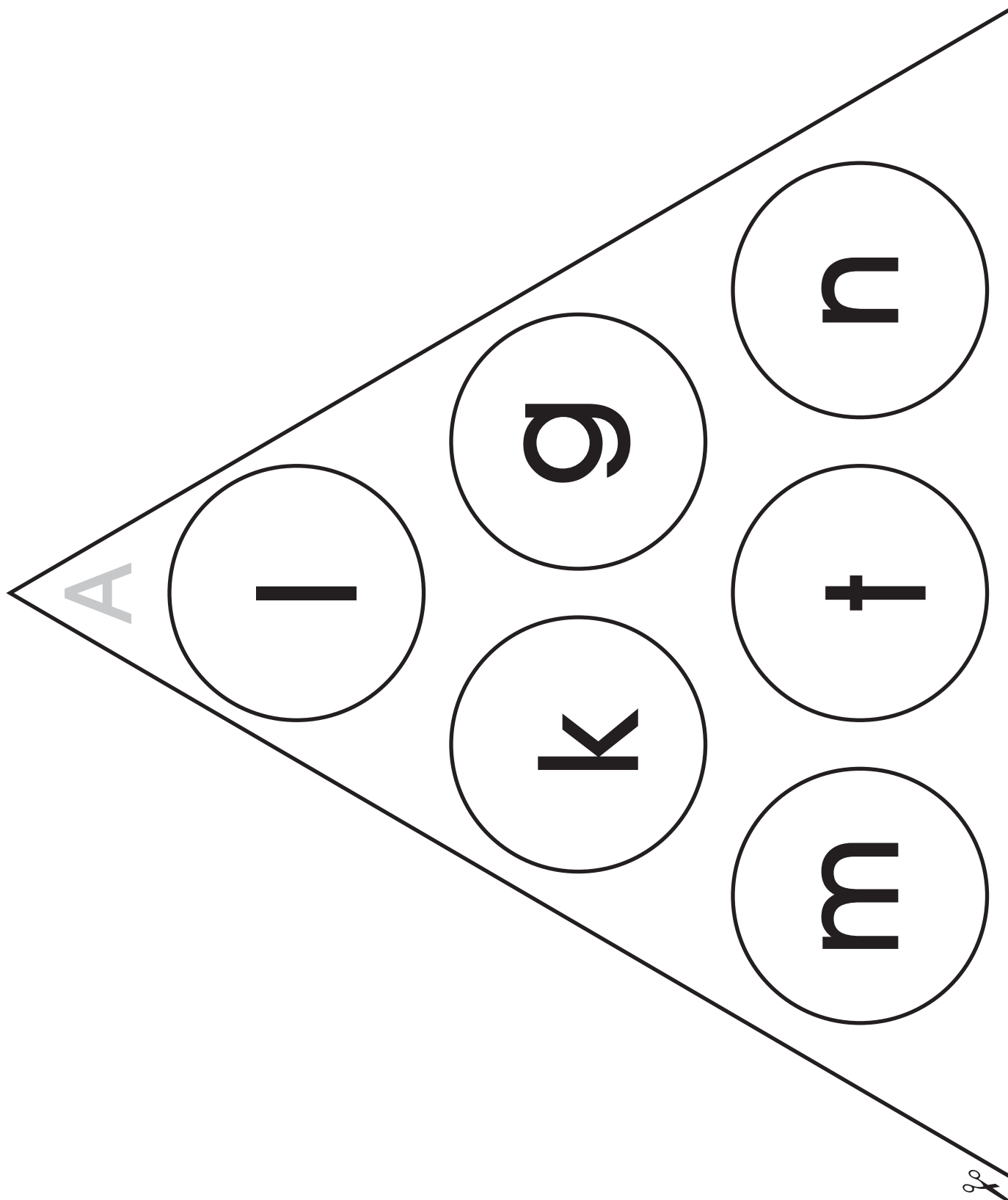

letter-sound triangle A

Phonics

Letter-Sound Pyramid

P.018

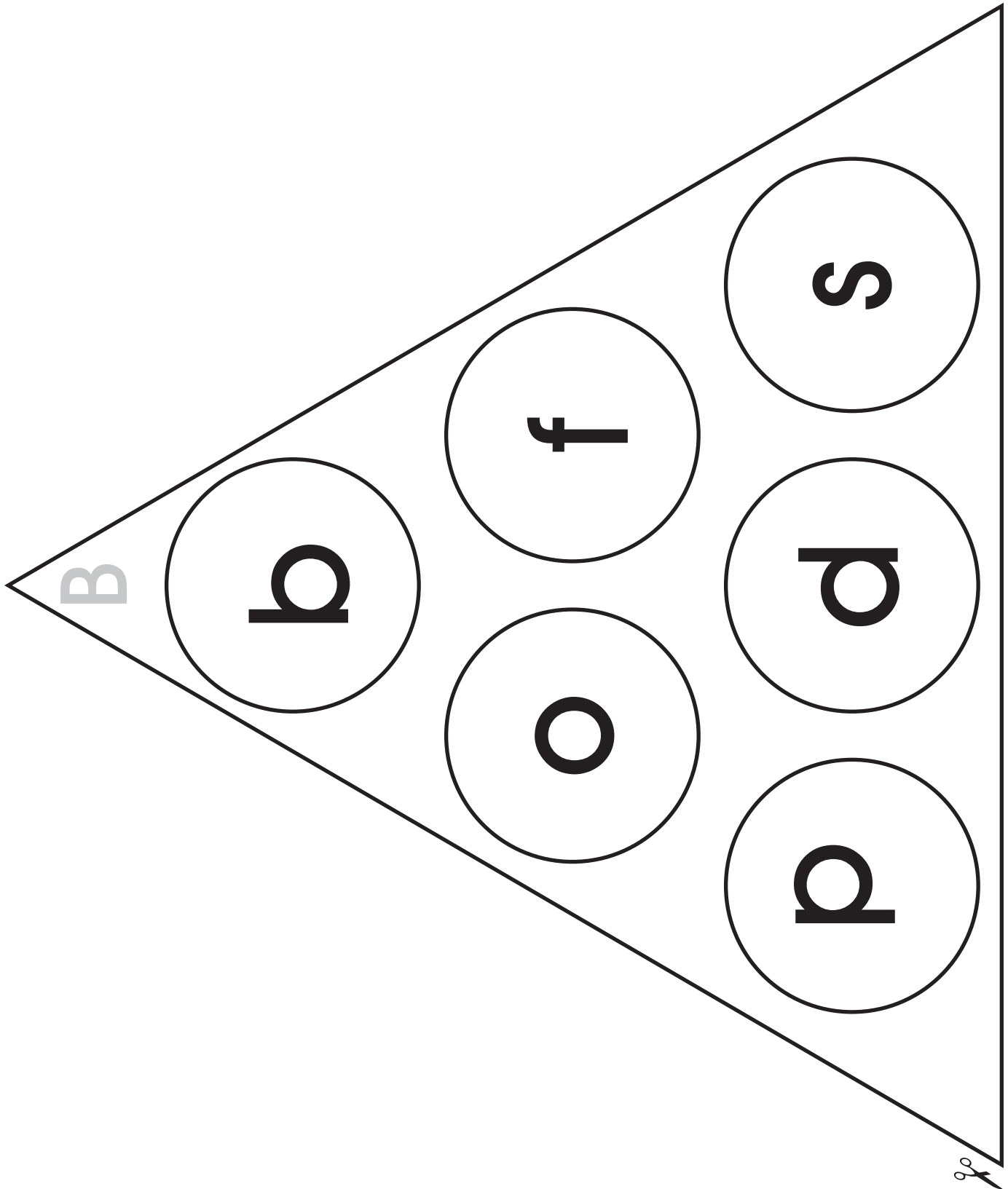

letter-sound triangle B

P.018

Letter-Sound Pyramid

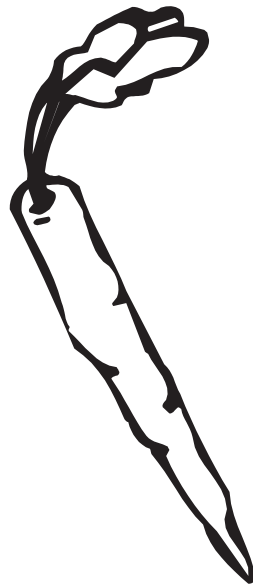
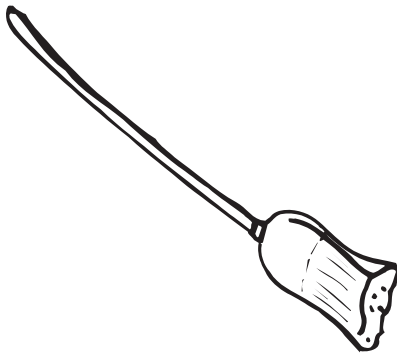
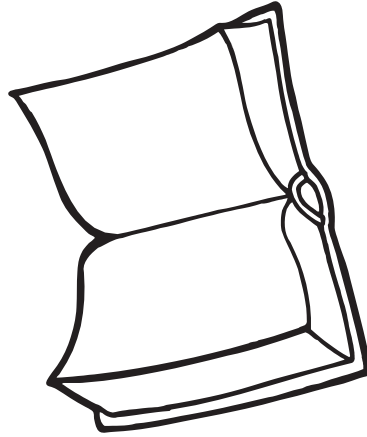

final sound picture cards: shovel, book, frog, broom, carrot, seven



Phonics

Letter-Sound Pyramid

P.018

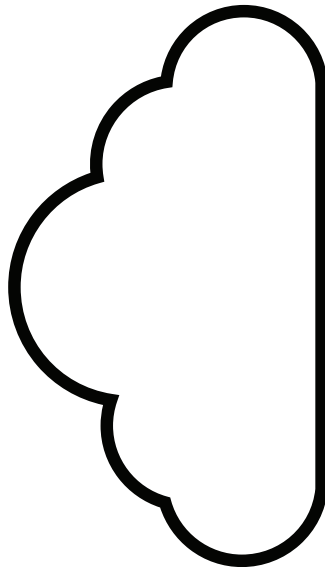
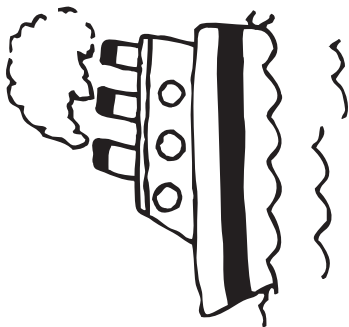
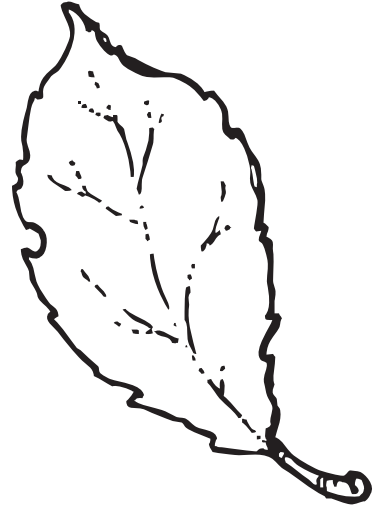
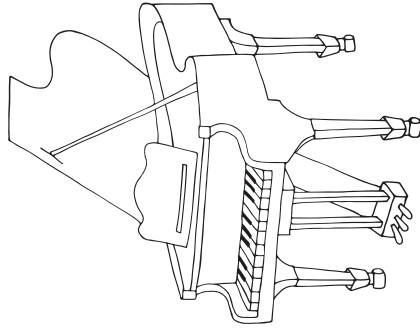
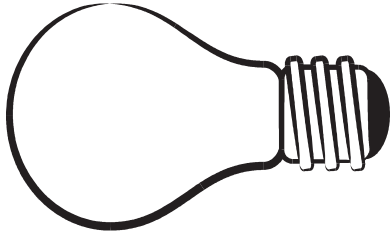

final sound picture cards: bulb, piano, leaf, ship, cloud, octopus



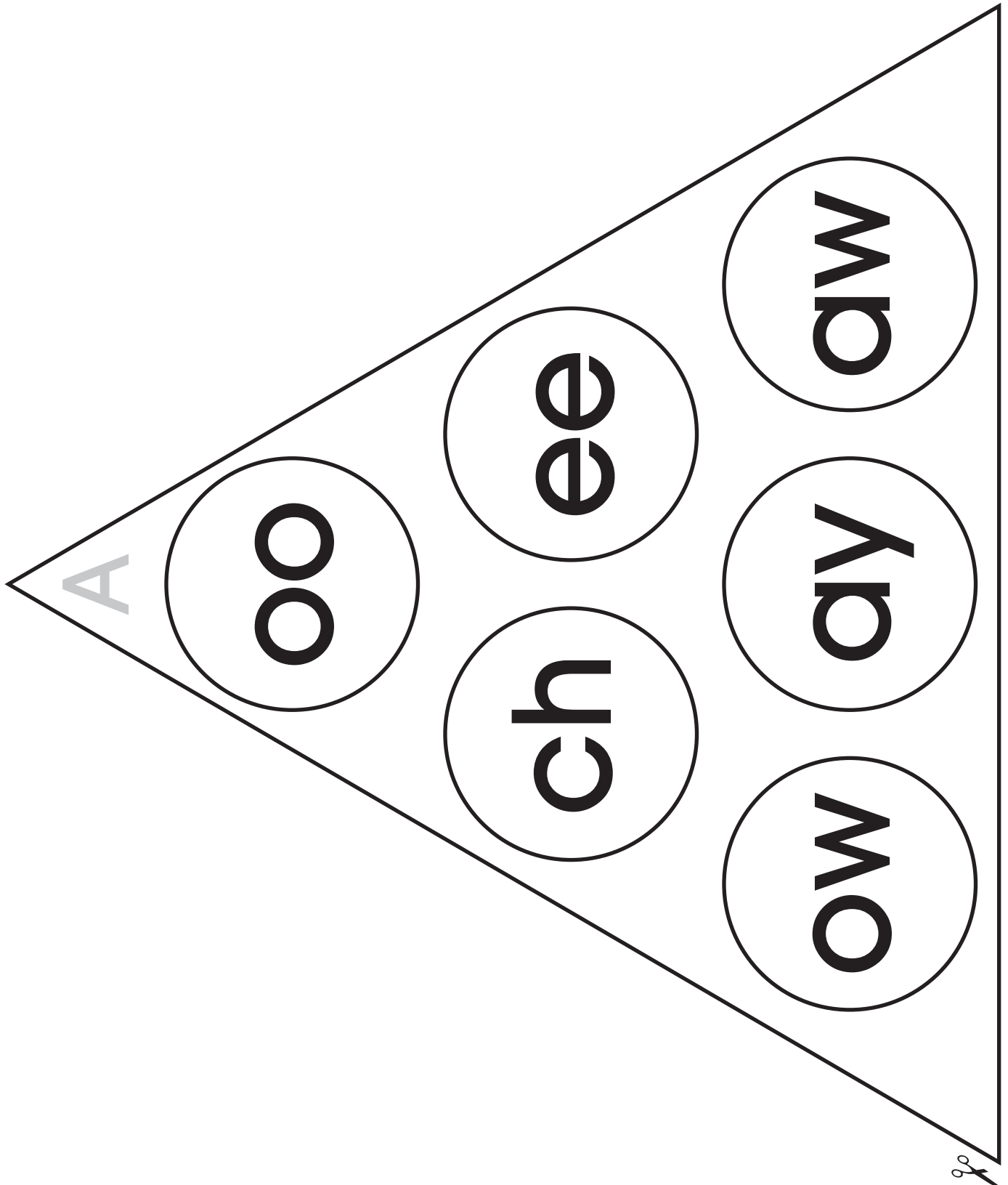

letter-sound triangle A

Phonics

Letter-Sound Pyramid

P.018

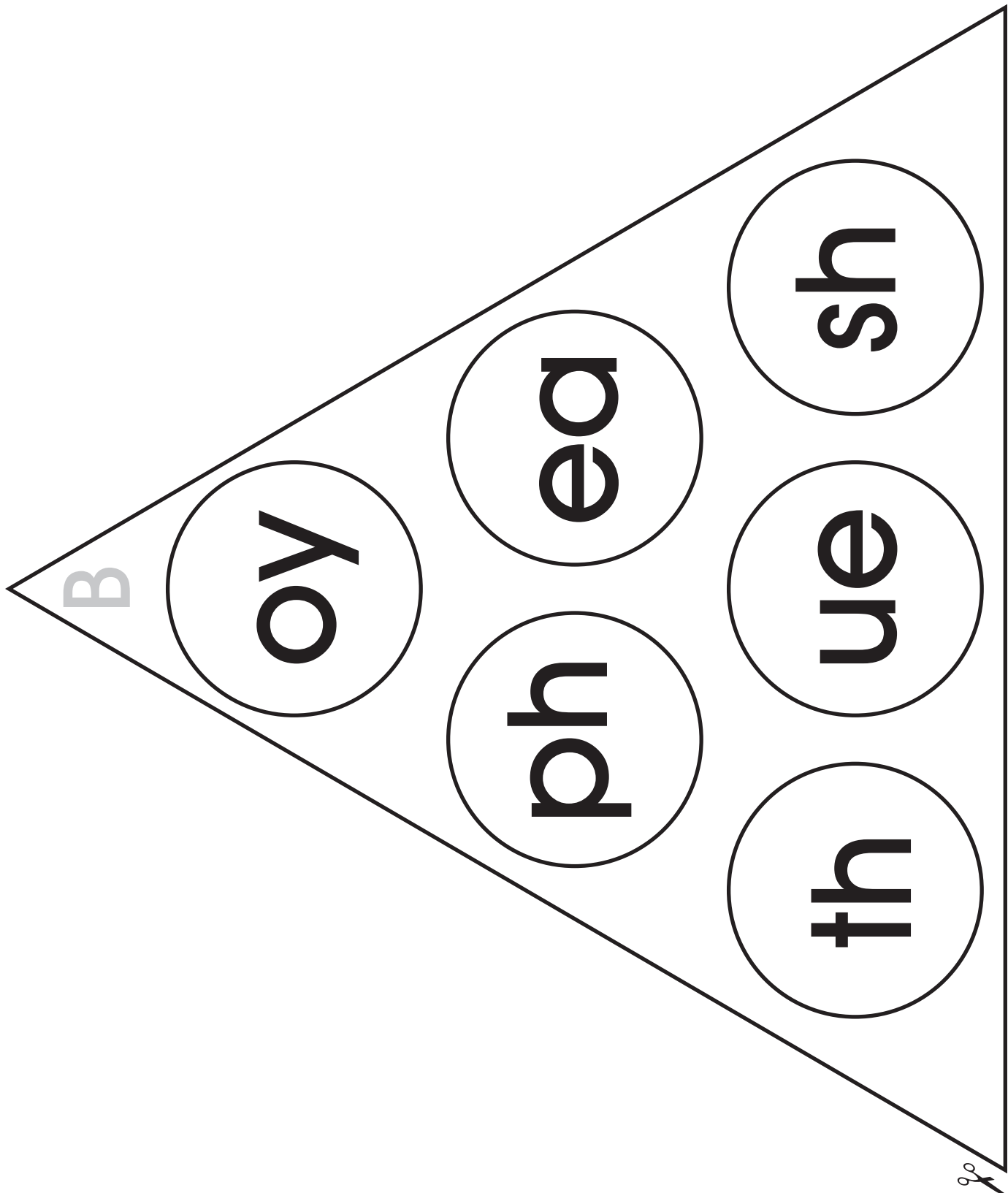

letter-sound triangle B

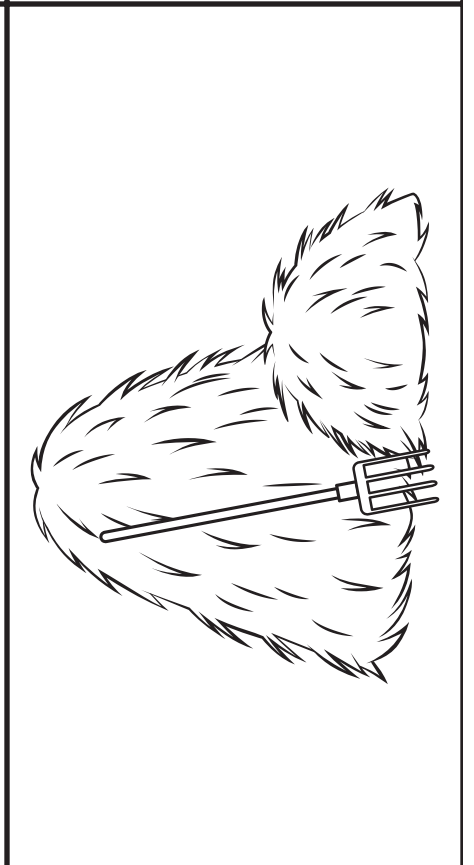
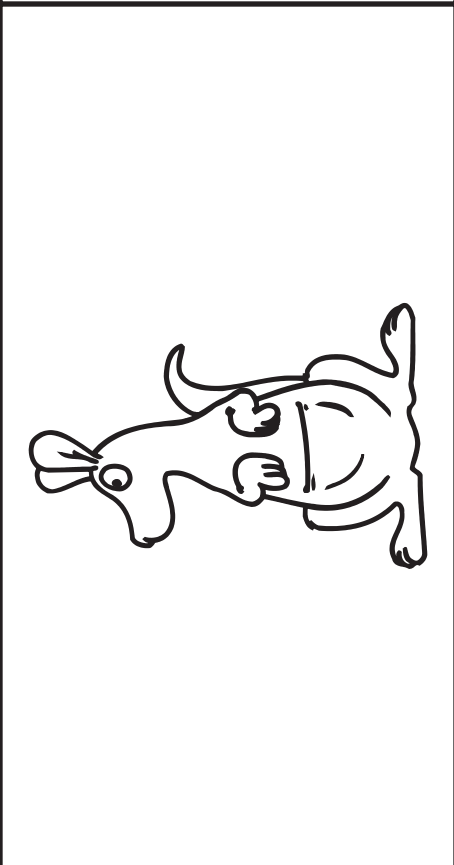
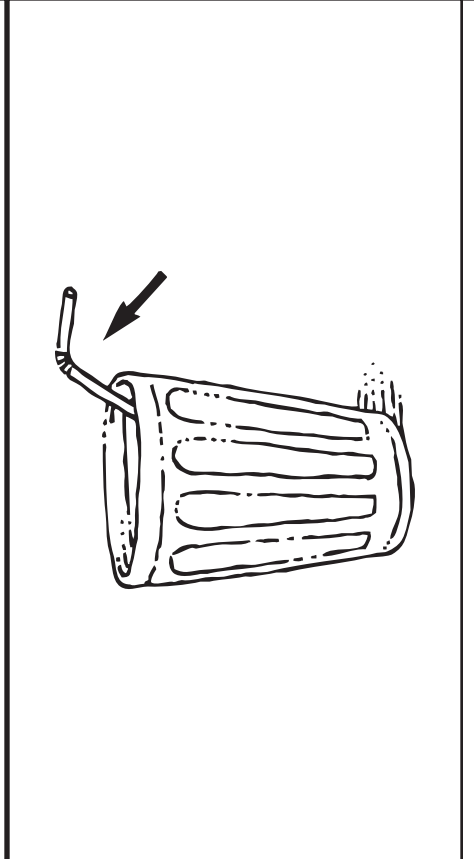
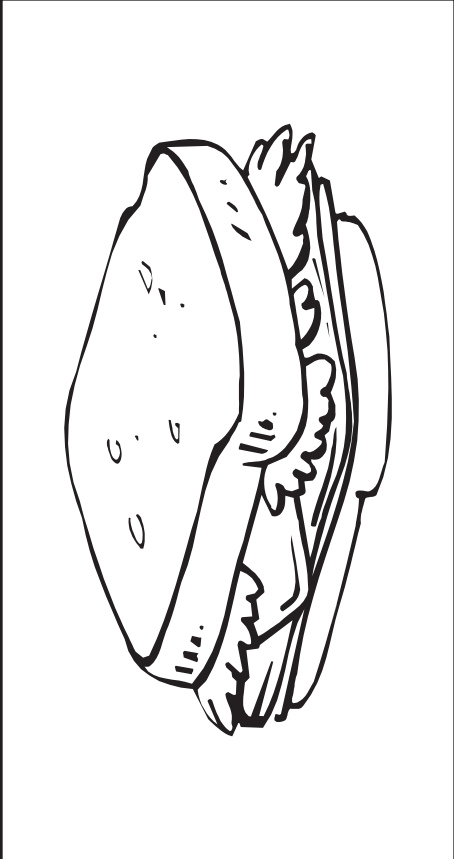

final sound picture cards: sandwich, cow, straw, kangaroo, three, hay



Phonics

Letter-Sound Pyramid

P.018

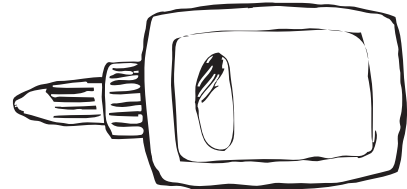
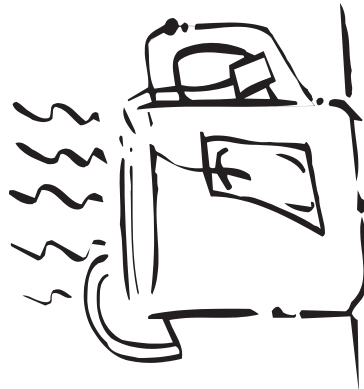
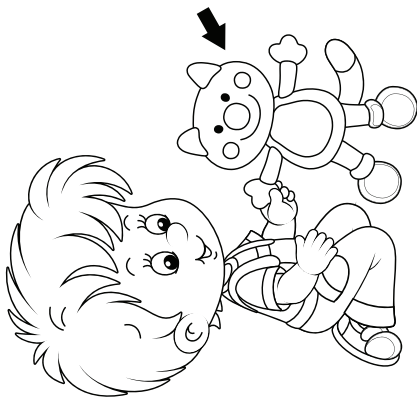
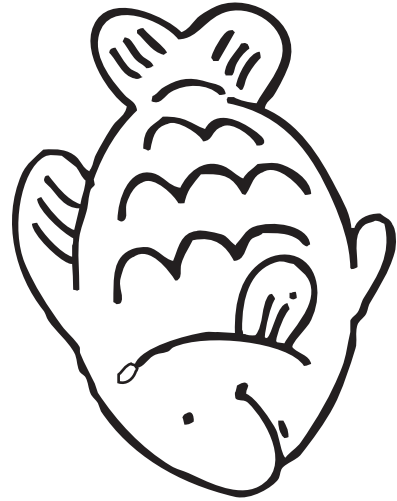
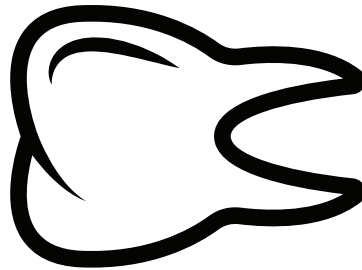
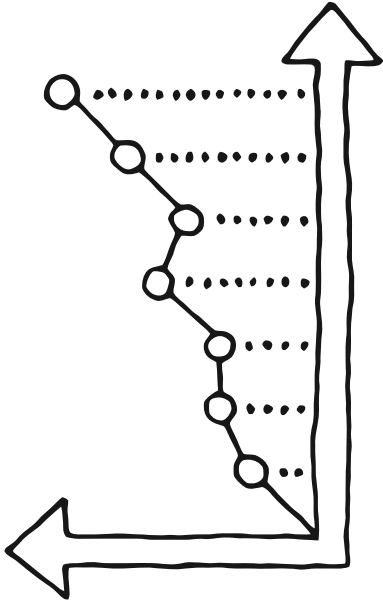

final sound picture cards: graph, tooth, fish, toy, tea, glue



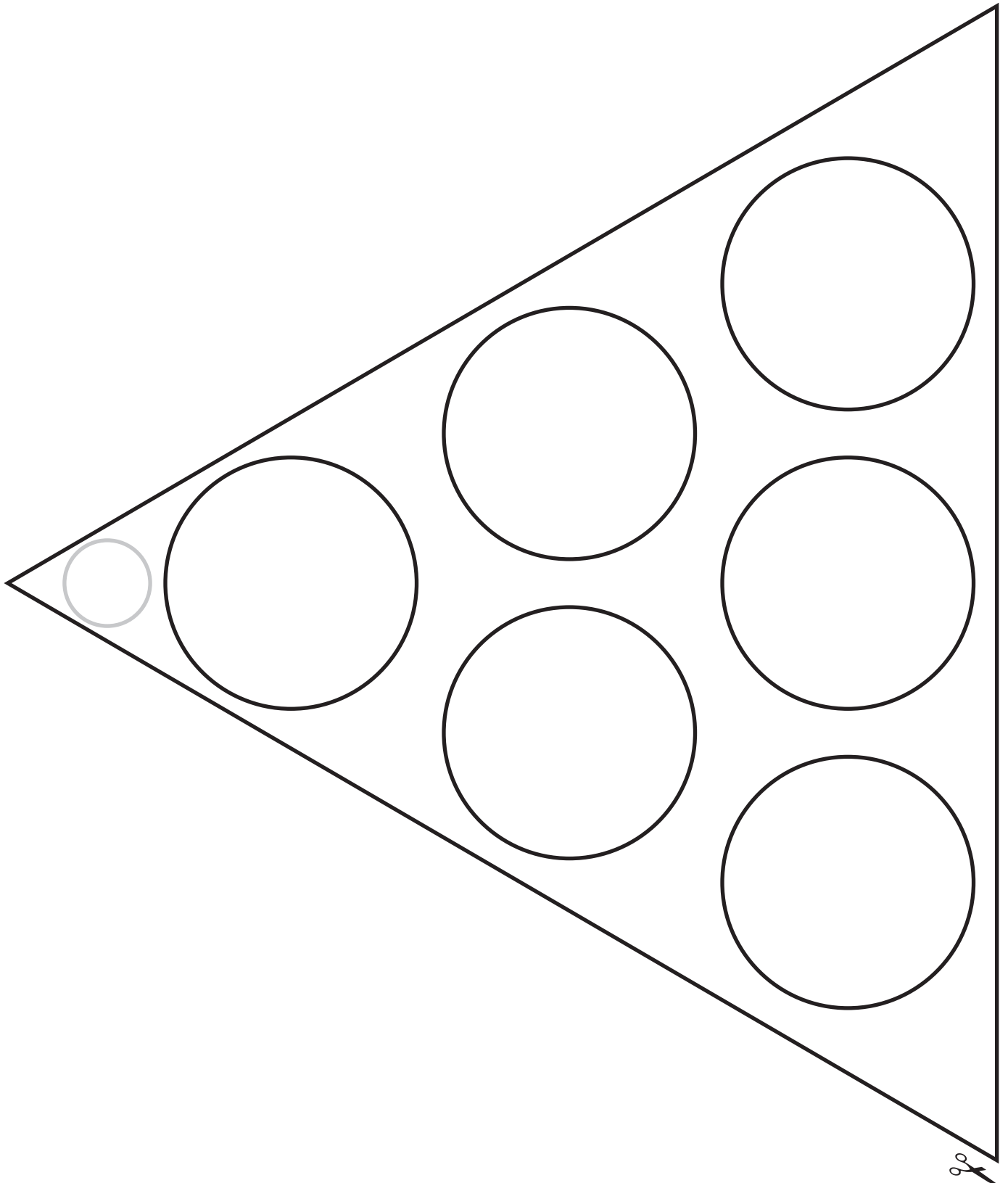

blank triangle