



Letter-Sound Folder Set

Objective

The student will match final phonemes to graphemes.

Materials

- ▶ Letter/letter combination cards
Choose four target letters or letter combination cards.
- ▶ File folder
Tape or glue target cards horizontally across the top of the file folder.
- ▶ Final sound picture cards
Choose picture cards that correspond to target letters.

Activity

Students sort final sound picture cards to letters on a file folder.

1. Place the open file folder on a flat surface. Place the final sound picture cards face up in a stack next to the file folder.
2. Taking turns, students select a card, name the picture, and say its final sound (e.g., “crib, /b/”).
3. Look for letter(s) on folder that corresponds to final sound, name it (i.e., “b”), and place the final sound picture card below that letter(s).
4. Continue until all cards are sorted.
5. Peer evaluation

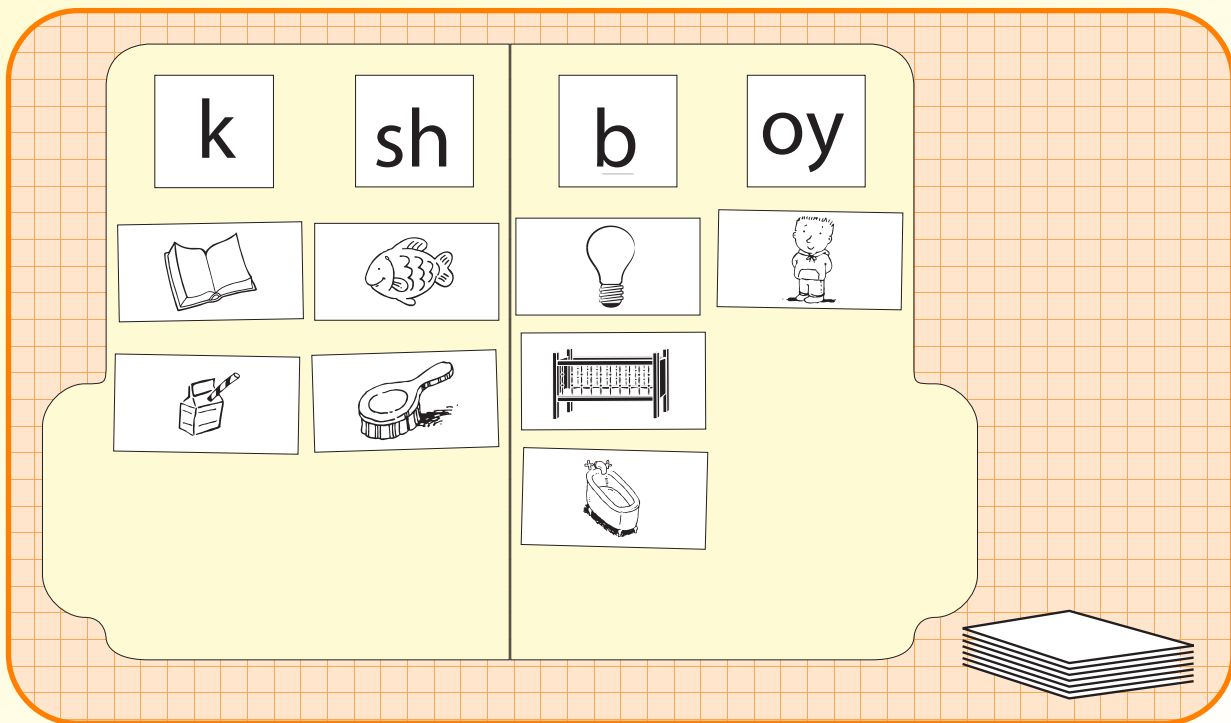

Extensions and Adaptations

- ▶ Use other target letter(s).
- ▶ Sort initial or medial sounds.

b	d	f
g	k	l
m	n	o
p	s	t

letter/letter combination cards



Phonics

Letter-Sound Folder Sort

P. 019

x

ar

sh

th

ch

ng

ow

aw

oo

oy



letter/letter combination cards

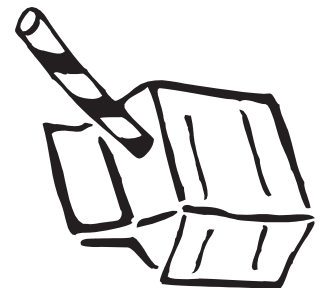
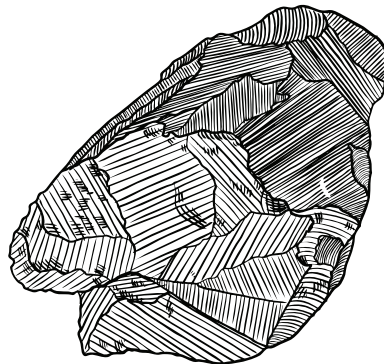
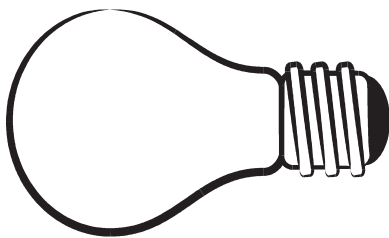
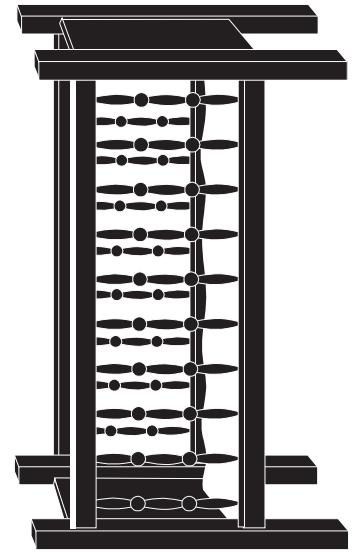
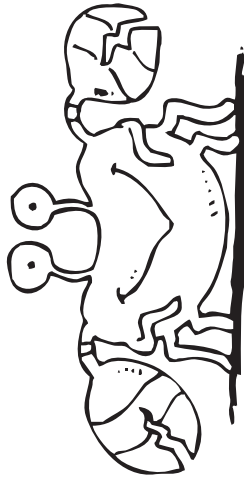
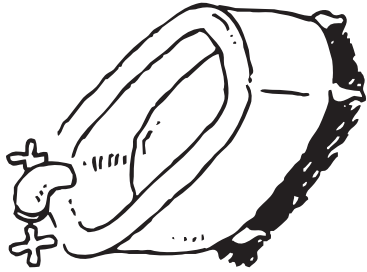

tub, crab, crib, bulb, rock, milk



Phonics

Letter-Sound Folder Sort

P. 019

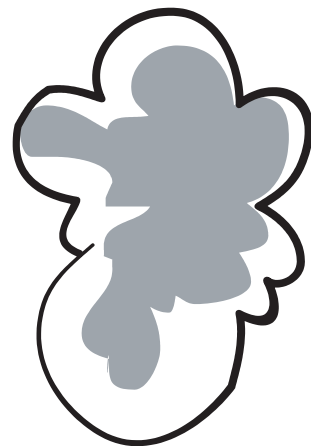
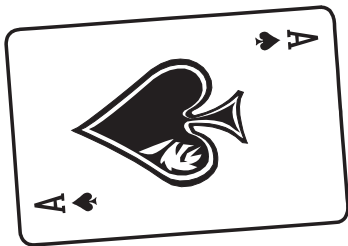
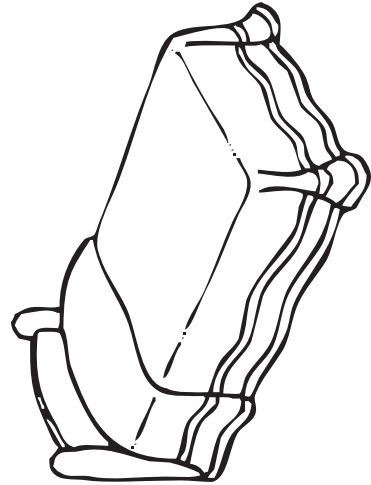
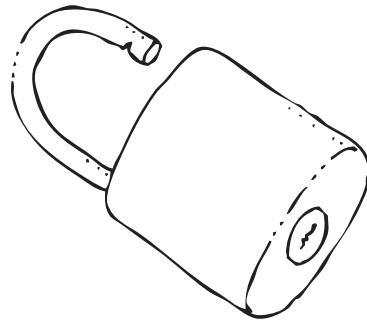
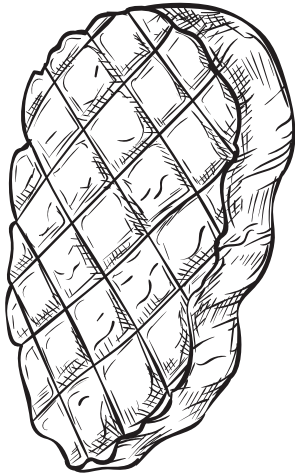

steak, lock, bed, card, bird, cloud



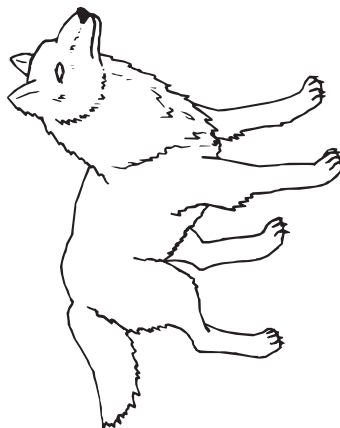
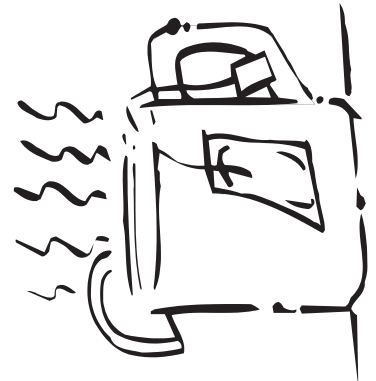

cookie, pea, tea, penny, wolf, elf



Phonics

Letter-Sound Folder Sort

P. 019

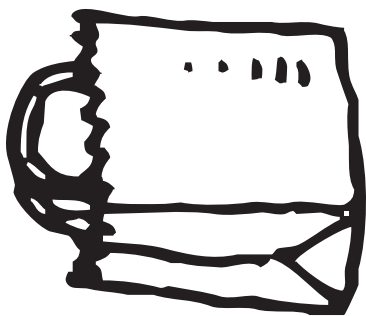
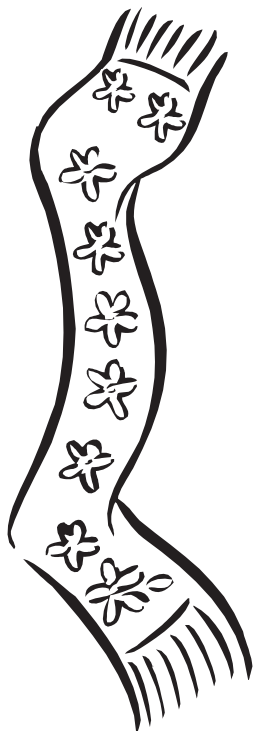
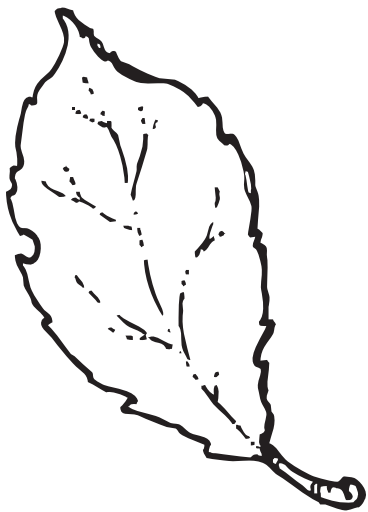

leaf, scarf, bug, bag, frog, log



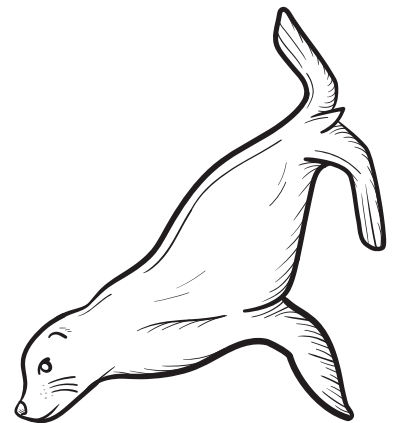
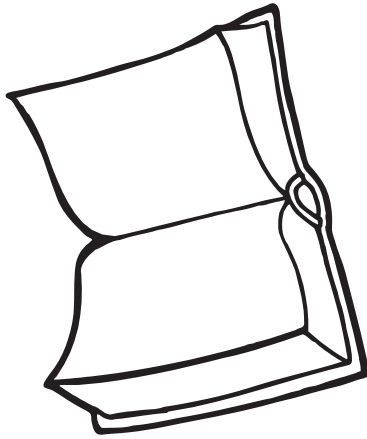

book, cake, stick, school, shovel, seal



Phonics

Letter-Sound Folder Sort

P. 019

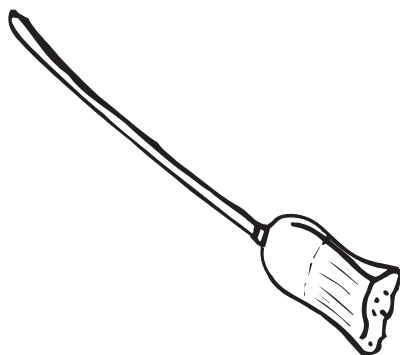
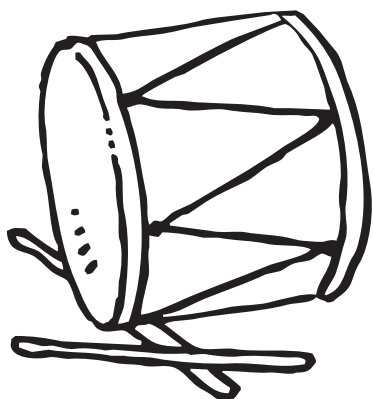
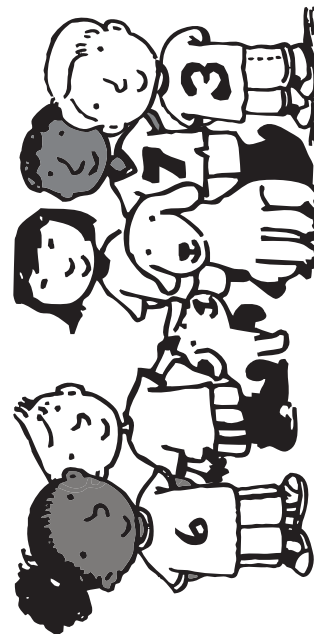
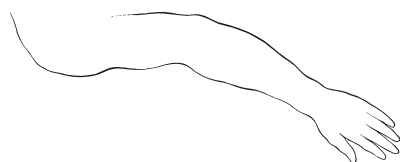
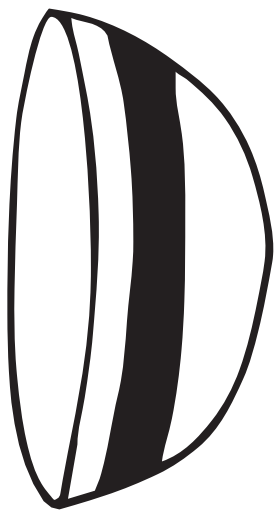

7

bowl, arm, team, drum, broom, seven



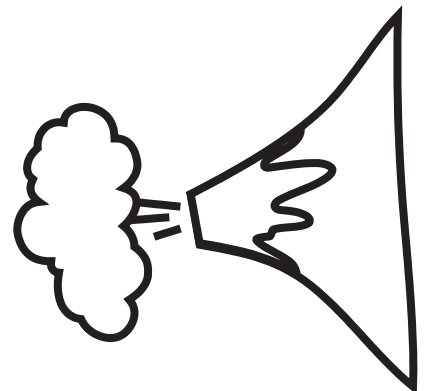
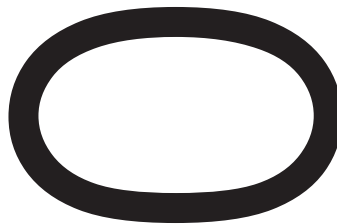
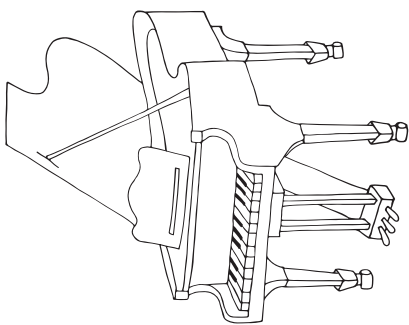
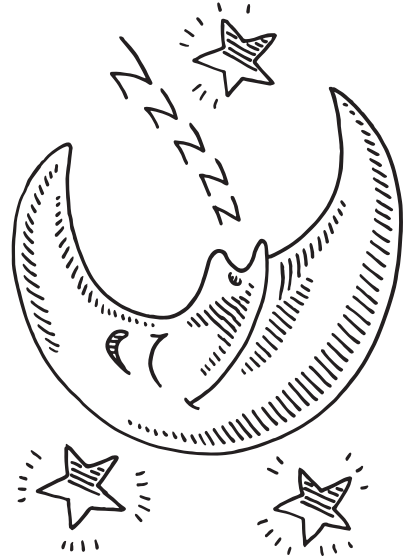
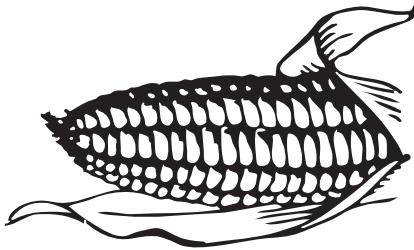
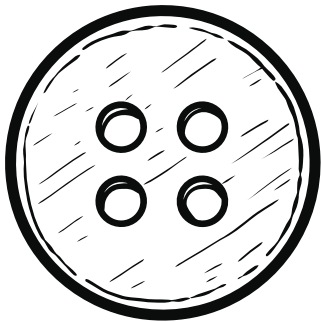

button, corn, moon, piano, zero, volcano



Phonics

Letter-Sound Folder Sort

P. 019

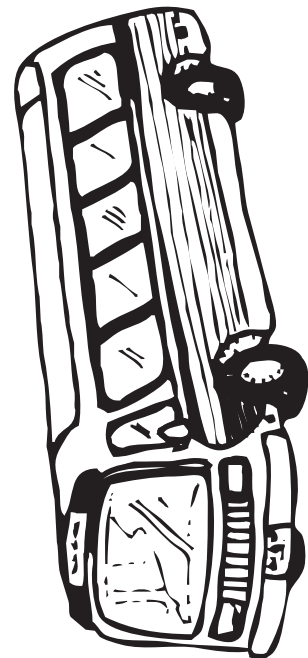
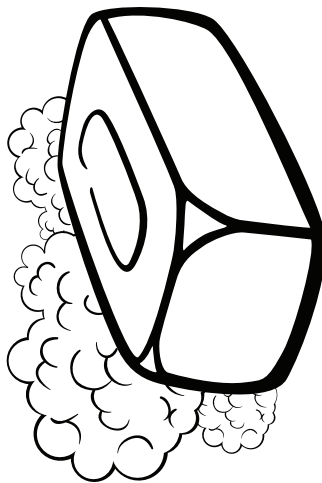
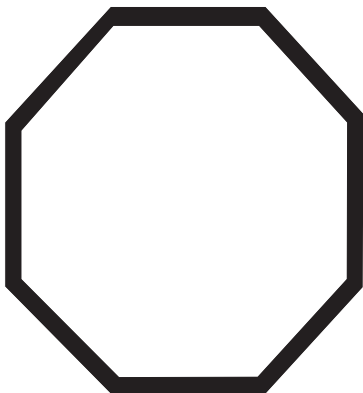
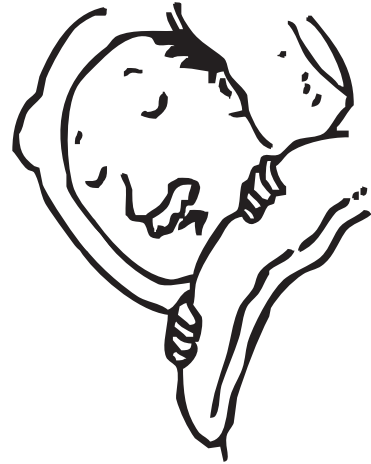
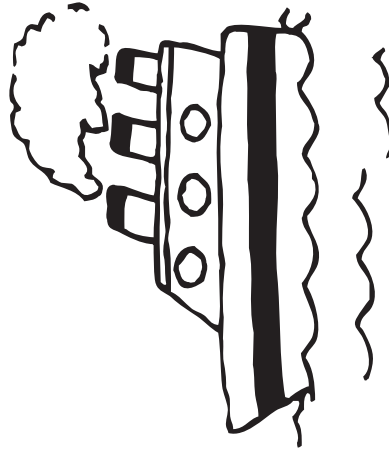
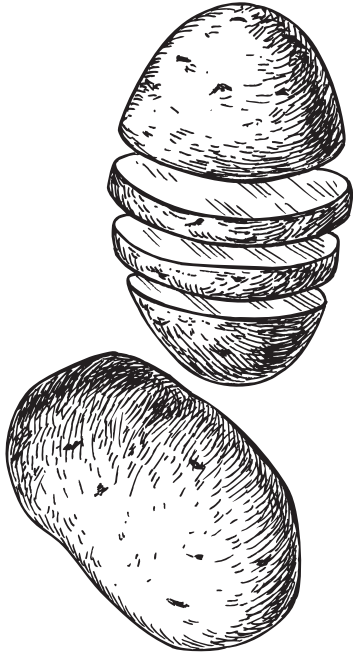

potato, ship, sleep, stop, soap, bus



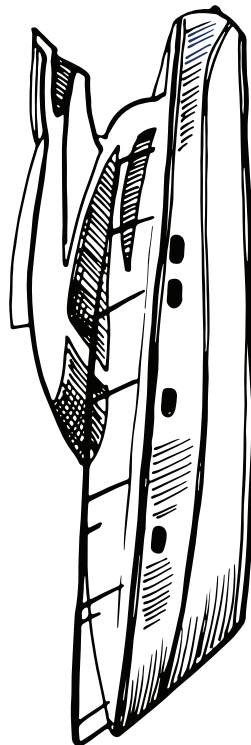
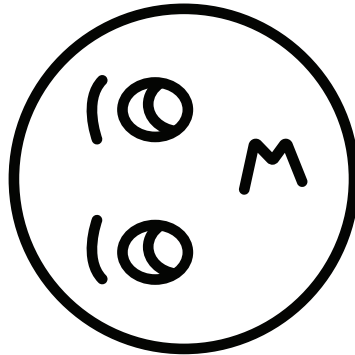
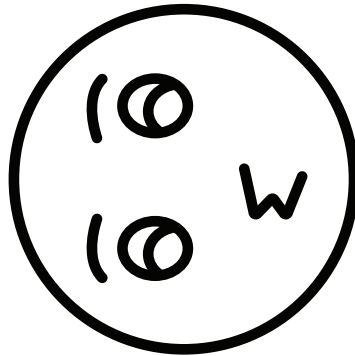
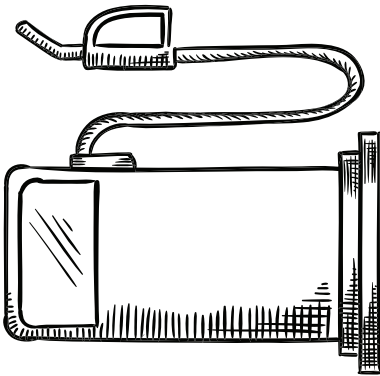

gas, kiss, octopus, carrot, boat, bat



Phonics

Letter-Sound Folder Sort

P. 019

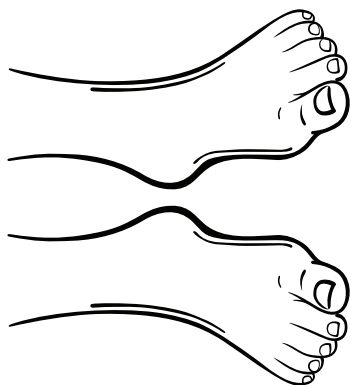

5

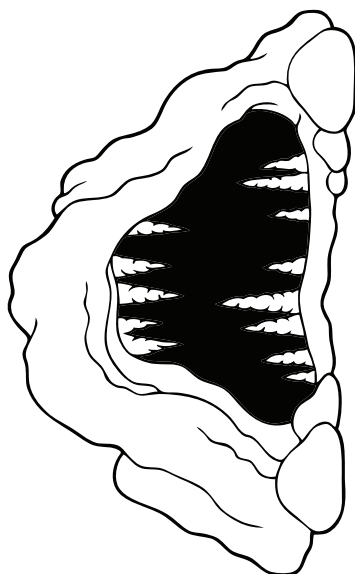
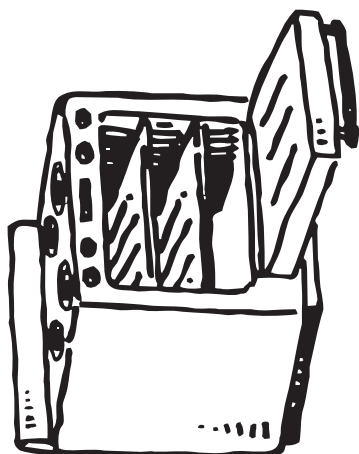

feet, five, sleeve, stove, cave, ox



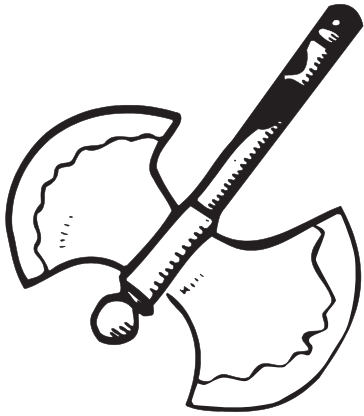

6

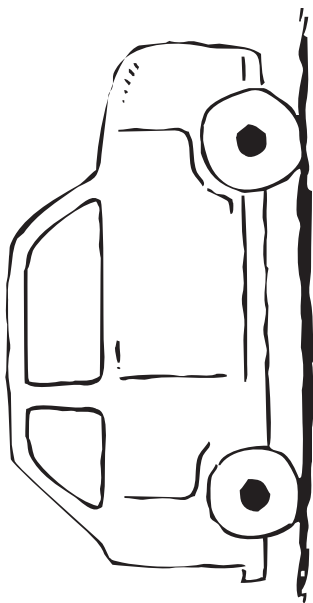
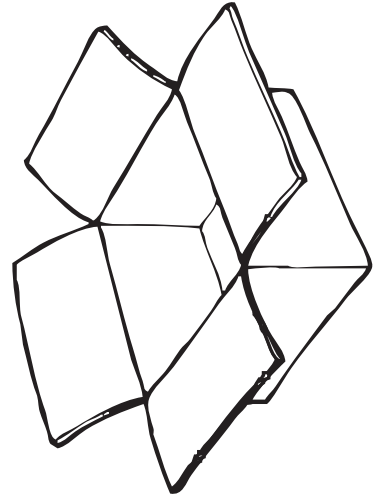

ax, six, box, car, star, jar



Phonics

Letter-Sound Folder Sort

P. 019

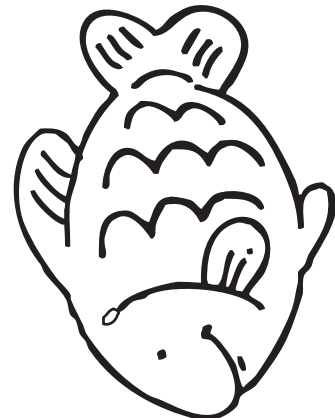
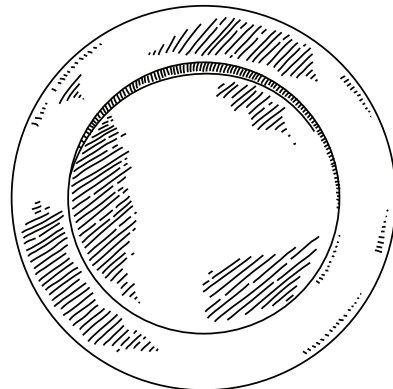
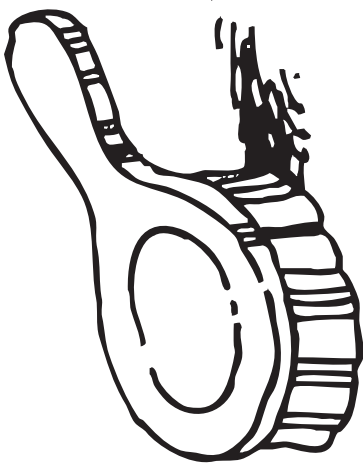
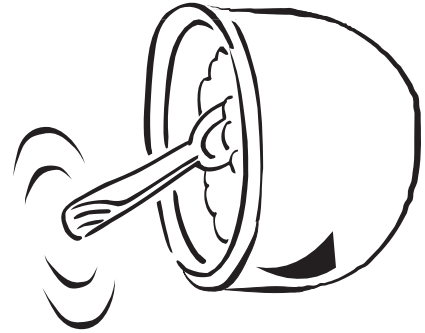
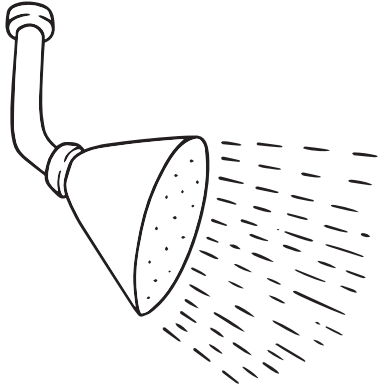

shower, river, stir, brush, dish, fish



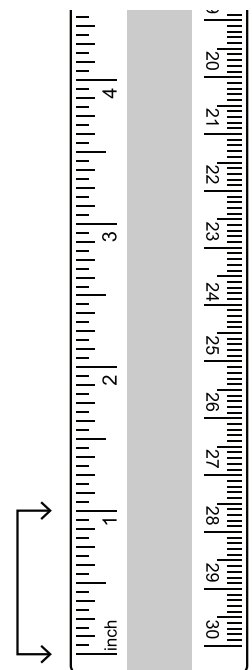
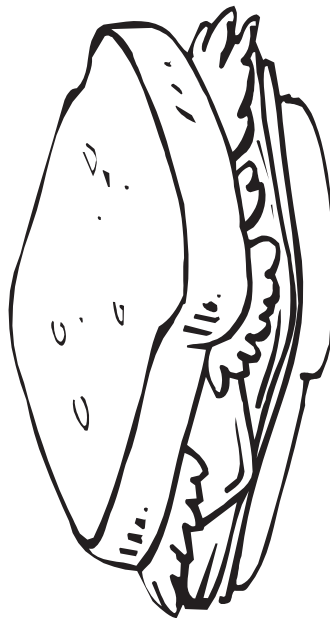
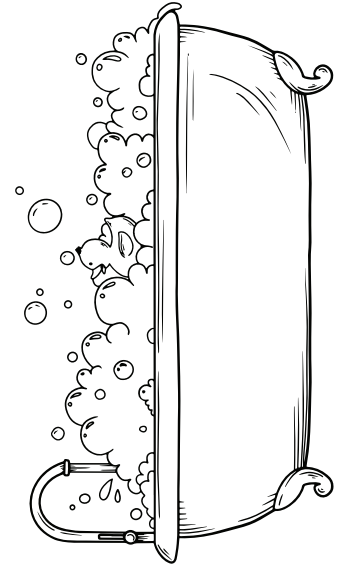
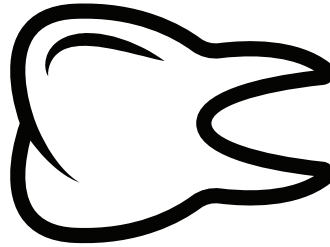
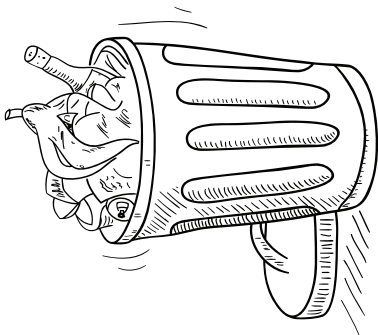

trash, tooth, bath, watch, sandwich, inch



Phonics

Letter-Sound Folder Sort

P. 019

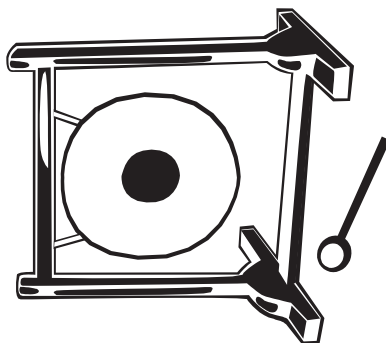
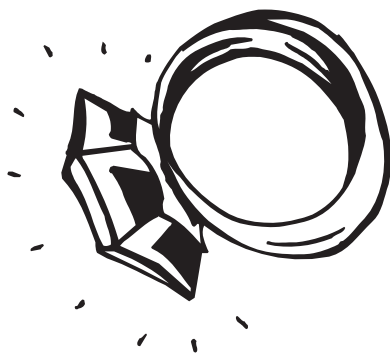
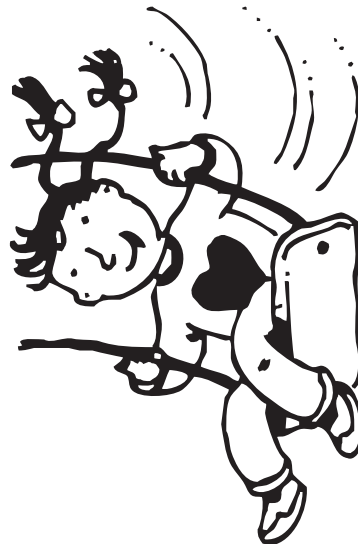
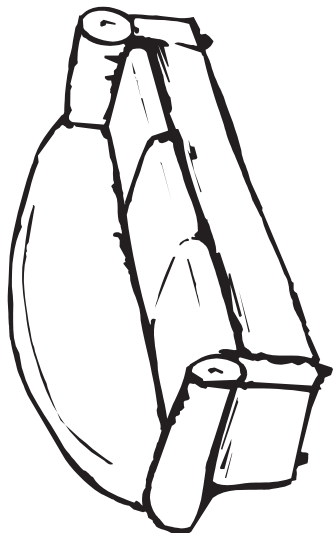

couch, king, swing, ring, gong, cow



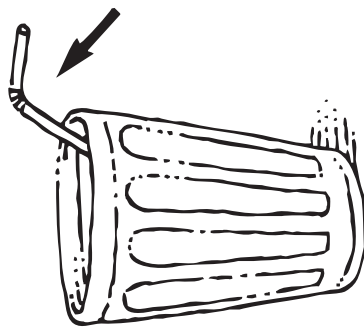
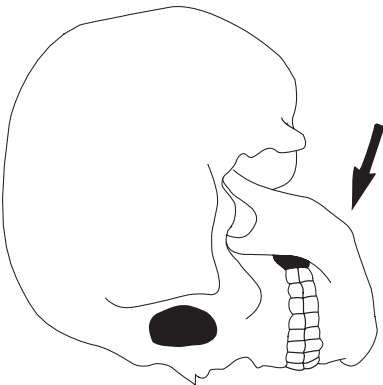
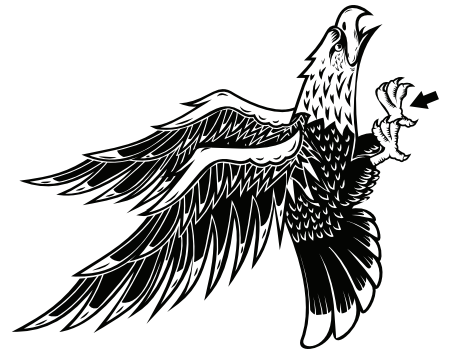

plow, draw, claw, jaw, straw, paw



Phonics

Letter-Sound Folder Sort

P. 019

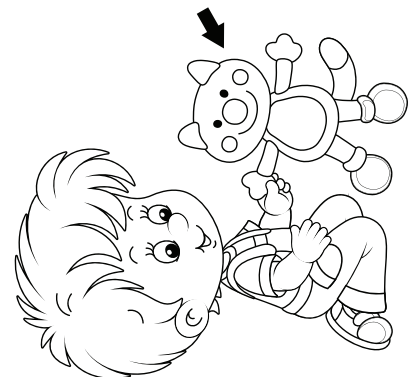
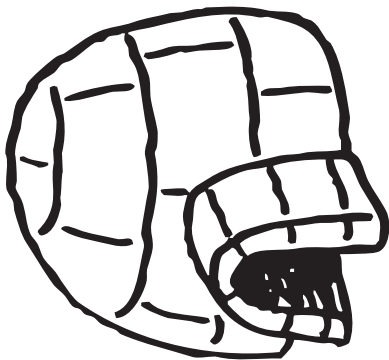
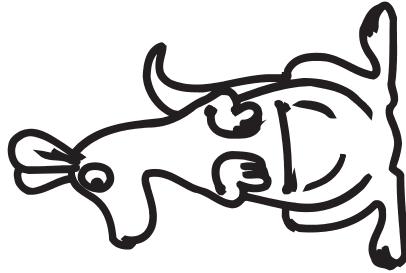

zoo, kangaroo, shampoo, igloo, boy, toy

